

Supporting information

for

**Temperature-Controlled Mechanochemistry for the Nickel-Catalyzed Suzuki-Miyaura -Type
Coupling of Aryl Sulfamates**

Robert R. A. Bolt,[°] Sarah Raby Buck,[°] Katharine Ingram,[¥] Jamie A. Leitch,^{°*} Duncan L. Browne^{°*}

[°] Department of Pharmaceutical and Biological Chemistry, School of Pharmacy, University College
London (UCL), Bloomsbury, London WC1N 1AX, United Kingdom

[¥] Syngenta, Jealott's Hill International Research Centre, Bracknell, Berkshire, RG42 6EY, United
Kingdom.

* duncan.browne@ucl.ac.uk, * j.leitch@ucl.ac.uk

Table of Contents

1. General Experimental.....	S3
2. Equipment used.....	S4
3. Preliminary optimisation studies	S8
4. Temperature-controlled mechanochemistry set-ups	S9
4.1. Heat gun set-up.....	S9
4.2. Heat device set-up	S11
5. Jar heater details	S13
5.1: Parts lists.....	S13
5.2: Images.....	S14
5.3: Internal wiring schematic.....	S15
6. Monitoring reaction temperatures	S16
7. Further experiments.....	S18
8. Variable temperature experiments using HP2	S19
9. Sustainability Metrics.....	S20
9.1: Process Mass Intensity (PMI) calculations	S20
9.2: E-factor calculations.....	S21
9.3: Space time yield (STY) calculations	S22
10: Extrusion protocols	S23
11. Experimental procedures	S27
11.1 Synthesis of starting materials.....	S27
11.1.1. Procedures for other activated phenol starting materials.....	S27
11.1.2. General Procedure A: Synthesis of aryl sulfamates	S30
11.1.3. General procedure B: Hydroxyl pyridine dimethylsulfamate synthesis	S32
11.2. Synthesis of C-C coupled products.....	S34
11.2.1. General Procedure C: Mechanochemical nickel-catalysed Suzuki-Miyaura cross coupling..	S34
12. NMR spectra.....	S42
13. References.....	S81

1. General Experimental

All chemicals were obtained from commercially available sources and used without additional purification unless stated otherwise.

Ball milling was carried out on a Retsch MM 400 Mixer mill and an IST500. Stainless steel milling jars and stainless-steel grinding balls were used unless stated otherwise.

Thin layer chromatography (TLC) was carried out on Merck TLC 60Å silica gel sheets and visualised using ultraviolet light of wavelength 254 nm.

Flash column chromatography (FFC) was performed using Merck/Sigma Aldrich silica gel (40-60 Å) as the stationary phase.

¹H NMR, ¹³C NMR and ¹⁹F NMR spectra were obtained on a Bruker Avance 400 at 400.13 MHz (¹H NMR at 400 MHz, ¹³C NMR at 101 MHz), Bruker Avance 500 fitted with a cryoprobe, at 500 MHz (¹H NMR at 500 MHz, ¹³C NMR at 126 MHz) and Bruker Avance Neo 700 at 700 MHz (¹⁹F NMR at 659 MHz, CDCl₃) at ambient temperature with chloroform-d as the deuterated solvent unless stated otherwise. All chemical shifts δ are reported in parts per million (ppm) and are referenced to the residual solvent peak (CHCl₃ – 7.26 and 77.16 ppm for ¹H and ¹³C respectively). Data for ¹H NMR are reported as: chemical shift (multiplicity, coupling constant (J, reported in Hertz - Hz) and integration). ¹³C NMR are reported as only chemical shift. Multiplicities are given as: s (singlet), d (doublet), t (triplet), q (quartet), h (hextet), m (multiplet), dd (doublet of doublet), ddd (doublet of doublet of doublets), dddd (doublet of doublet of doublet of doublets). Complex splitting patterns are reported as m.

High resolution mass spectral (**HRMS**) data were obtained on a Micromass Q-TOF Premier Tandem Mass Spectrometer coupled to nano acquilty LC. Spectra were obtained using electrospray (ES)

Infrared spectra were recorded on an Agilent Cary 630 FTIR spectrometer.

Melting points were measured on a Stuart SMP10 melting point apparatus.

2. Equipment used

Mixer Mills: Mechanochemical reactions were conducted using a Retsch MM400 mixer mill and an IST500 high-energy mixer mill at the frequency denoted where relevant (below see www.retsch.com and www.insolidotech.org for more details)

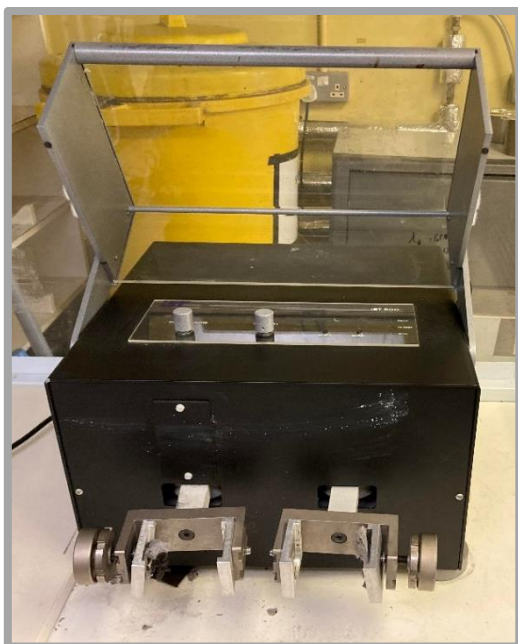
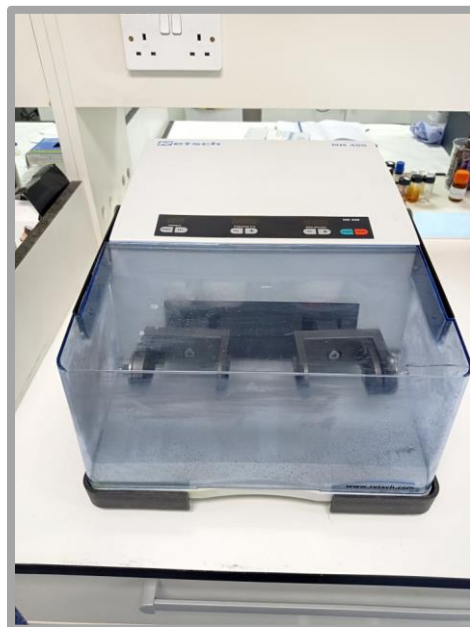

Jars: Mechanochemical reactions were conducted using stainless steel jars (316 SS grade) with Teflon seals which were fabricated in-house (15 mL left, 30 mL right).



Balls: Stainless steel balls (316 SS grade) were purchased from Bearing Boys limited (www.bearingboys.co.uk) at a variety of sizes (see below - left to right 2 g, 3 g, 4 g, 7 g, 8 g, 12 g)



High-temperature mechanochemistry: Mechanochemical reactions conducted at high temperature using a heat-gun apparatus were carried out using an evolution HDG200 heat-gun set to the appropriate temperature (see below).



Retsch MM400 Lid removal: For heat gun experiments both the lid and the plastic cover on the milling arms need to be removed (see below). The plastic cover on the milling arms are removed using a Phillips screwdriver.

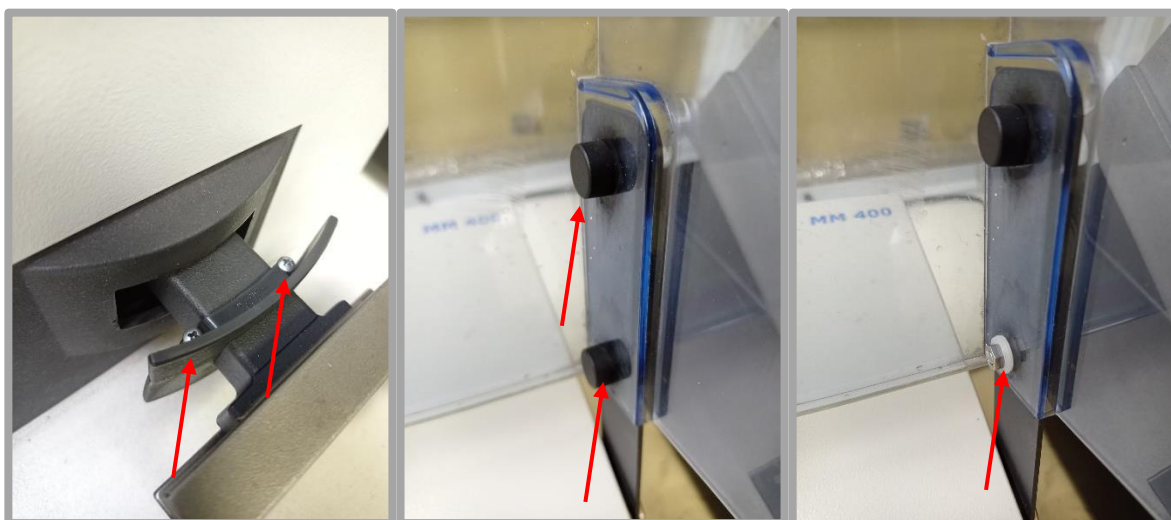

The plastic safety lid is removed by first removing the plastic caps over the bolt and then removing the nut and plastic washer (see above).

Retsch MM400 base plate removal: For heat band experiments both the milling arms covers, and the base plate needs to be removed. See above to remove the plastic covers on the milling arms. To remove the base plate, place the instrument on its side and remove the three screws with a M4 Allen key (see below).

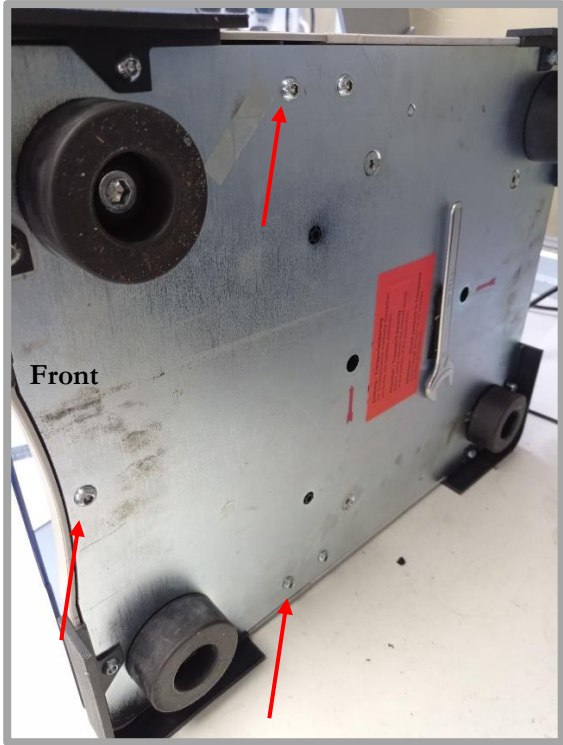
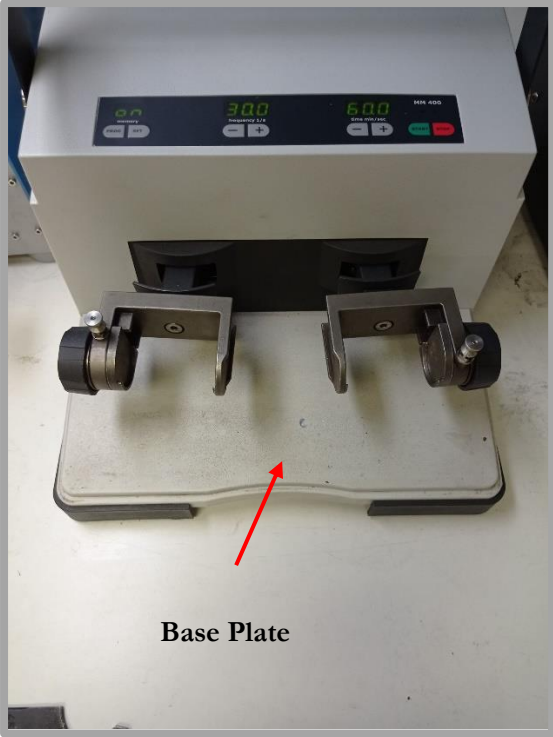

3. Preliminary optimisation studies

Table S1. Preliminary optimisation studies on naphthyl sulfamate derivative

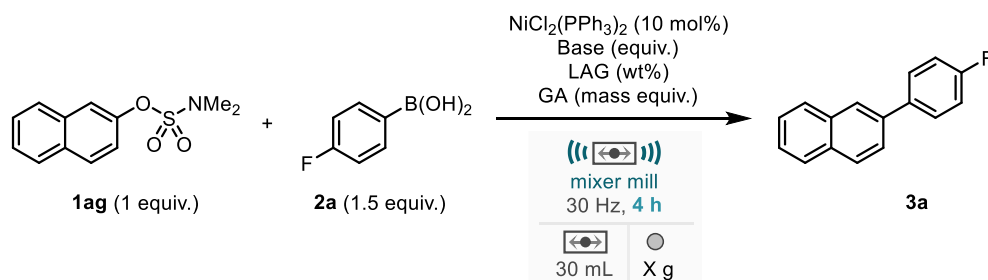

Entry	LAG (wt%) ^a	GA (mass equiv.) ^b	Ball Mass (g)	Base (equiv.)	Yield (%) ^c
1 ^d	None	None	3	K ₃ PO ₄ (3)	-
2	None	None	3	K ₃ PO ₄ (3)	0
3	EtOH (5)	None	3	K ₃ PO ₄ (3)	57
4	EtOH (10)	None	3	K ₃ PO ₄ (3)	34
5	EtOH (20)	None	3	K ₃ PO ₄ (3)	0
6	EtOH (5)	NaCl (0.5)	3	K ₃ PO ₄ (3)	62
7	EtOH (5)	NaCl (1.0)	3	K ₃ PO ₄ (3)	65
8	EtOH (10)	NaCl (0.5)	3	K ₃ PO ₄ (3)	57
9	EtOH (10)	NaCl (1.0)	3	K ₃ PO ₄ (3)	74
10	EtOH (10)	NaCl (2.0)	3^e	K₃PO₄ (3)	95 (75)^f
11	EtOH (10)	NaCl (1.0)	2	K ₃ PO ₄ (3)	45
12	EtOH (10)	NaCl (1.0)	4	K ₃ PO ₄ (3)	77
13	EtOH (10)	NaCl (1.0)	7	K ₃ PO ₄ (3)	80
14	EtOH (10)	NaCl (1.0)	8	K ₃ PO ₄ (3)	58
15	EtOH (10)	NaCl (1.0)	12	K ₃ PO ₄ (3)	40
16	EtOH (10)	NaCl (1.0)	7	Na ₃ PO ₄ (3)	0
17	EtOH (10)	NaCl (1.0)	7	CsF (3)	0
18	EtOH (10)	NaCl (1.0)	7	K ₂ CO ₃ (3)	0
19	EtOH (10)	NaCl (1.0)	7	<i>t</i> -BuOK (3)	20
20	EtOH (10)	NaCl (1.0)	7	K ₃ PO ₄ (4)	82
21	EtOH (10)	NaCl (1.0)	7	K ₃ PO ₄ (5)	77
22	EtOH (10)	NaCl (1.0)	7	K ₃ PO ₄ (6)	11
23	EtOH (10)	NaCl (1.0)	7	K ₃ PO ₄ (7)	35

^a LAG = liquid assisted grinding agent. Weight% values were calculated against the sum of all reaction components, excluding the grinding auxiliary. 10 weight% roughly translates to 0.122 $\mu\text{L}/\text{mg}$.

^b GA = Grinding Auxiliary. Mass equivalents calculated from sum of all solid reaction components (i.e. excluding LAG agent).

^c Yields determined by ¹H NMR of the crude reaction mixture using mesitylene (23 μL , 0.167 mmol) as an internal standard.

^d No nickel catalyst

^e 3 g ball refers to a 9 mm stainless steel ball

^f Isolated yield after silica gel chromatography

4. Temperature-controlled mechanochemistry set-ups

4.1. Heat gun set-up

1. Ball added to milling jar
2. Chemicals added

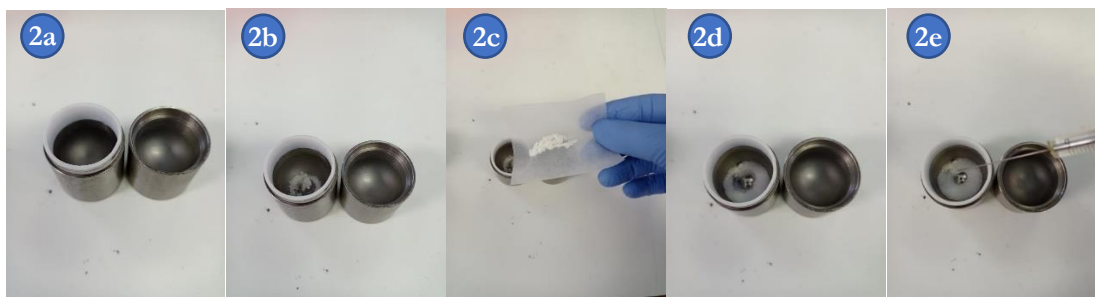

3. Jar closed
4. Placed on mixer mill



5. Heat gun set positioned and safety screen placed (Due to the removal of the devices protective cover)
6. Heat gun started
7. Grinding immediately initiated



8. Reaction material removed using spatula and washed out using ≈ 30 mL EtOAc and 30 mL water and sonicated to break up larger particles (left; before and right; after)

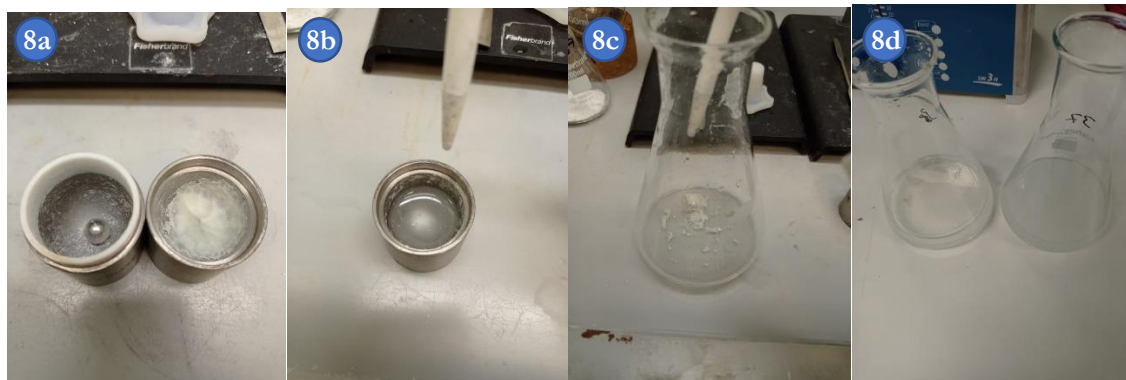

9. The organic phase (EtOAc top layer) was washed with 1.1M NaOH, Water and Brine and the solution was then dried over MgSO_4 and filtered

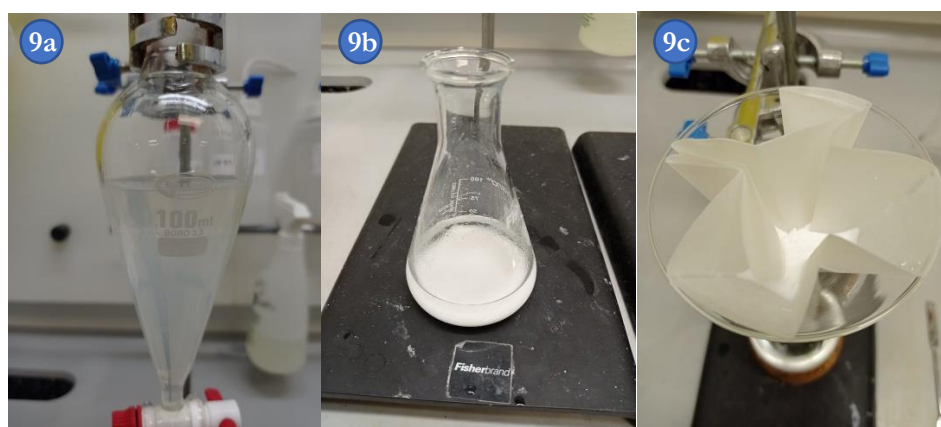

10. The solvent was then removed using a rotary evaporator to produce the crude product. Mesitylene was added as internal standard.



4.2. Heat device set-up

1. Steps 1-3 the same as 4.1
2. Band heater added over jar and tightened into position
3. Placed on mixer mill



4. Cover closed (to turn off magnetic safety switch feature)



5. Control unit of band heater set to required temperature



6. Milling commenced

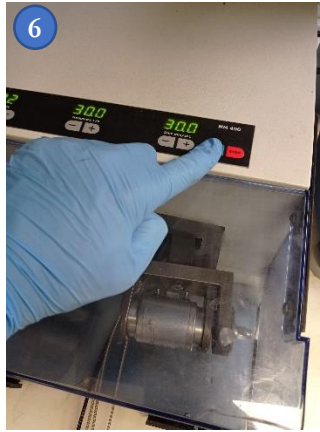

7. Steps 8-10 the same as 4.1

5. Jar heater details

5.1: Parts lists

Table S2: Parts list for PID-Controlled Unit

Item	Supplier	Code	Quantity*
Mains lead	RS Components	262-1126	1
IEC Filter	RS Components	123-0274	1
Rocker Switch Red	RS Components	419-782	1
Rocker Switch Green	RS Components	419-788	1
PID controller	RS Components	124-1059	2
Magnetic Switch	CPC Farnell	PRM-SA-002	2
Magnet	CPC Farnell	PRA-SA-003	2
Thermocouple Plug J	RS Components	455-9714	2
Thermocouple Plug socket J	RS Components	455-9691	2
Housing unit	RS Components	232-910	1
C14 Cable mount IEC Male	RS Components	776-9113	4
C13 IEC outlet F	CPC Farnell	4787.1	4

* Quantity required to make one heating unit excluding band heaters

Sourced from:

- RS Components – <https://uk.rs-online.com/web/>
- CPC Farnell - <https://cpc.farnell.com/>

Table S3: Parts list for band heaters

Item	Supplier	Code	Quantity*
Mica Heater Band - 28mm Ø x 50mm 240w 240v, Type Low Cost with 500mm (3 core) Braided Leads + Type 'J' Thermocouple – for 15 mL jar	Gary Duncan	MHB39010	2
Mica Heater Band - 35mm Ø x 50mm 300w 240v, Type Low Cost with 500mm (3 core) Braided Leads + Type 'J' Thermocouple – for 30 mL jar	Gary Duncan	MHB39011	2

* Quantity required to have two sets of interchangeable jar sizes

Sourced from:

- Gary Duncan Ltd - <https://garyduncan.co.uk/>

5.2: Images

PID-Controlled Unit front view: A – PID Controller, B – Rocker Switch

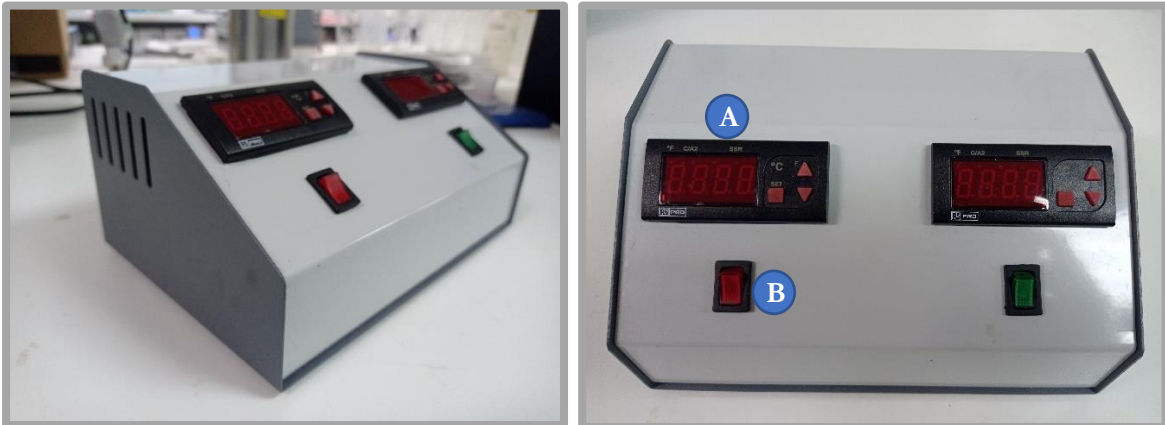

PID-Controlled Unit back view: C – IEC Filter, D – Thermocouple plug socket type J, E – Grounding Screw, F – C13 IEC outlet

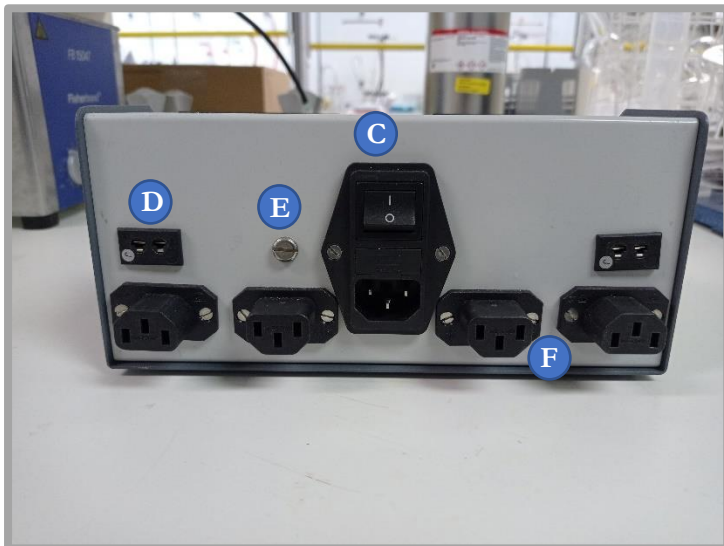

Magnetic reed switch diagram: A magnetic reed switch is a switch induced by the magnetic field upon it. This one is normally an open switch (NO) where the contacts are not conducted when no magnet is nearby, however upon the introduction of a magnet the contacts close completing the circuit, see schematic below.

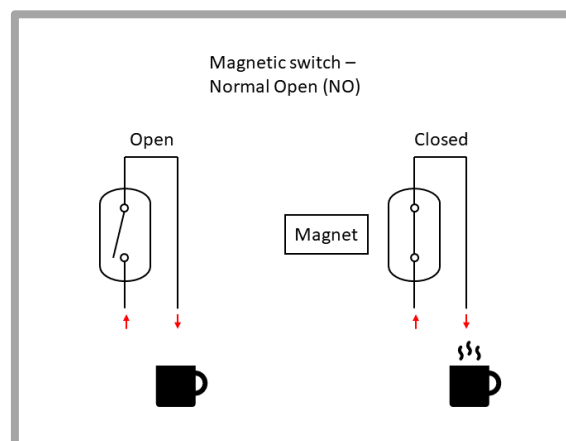

5.3: Internal wiring schematic

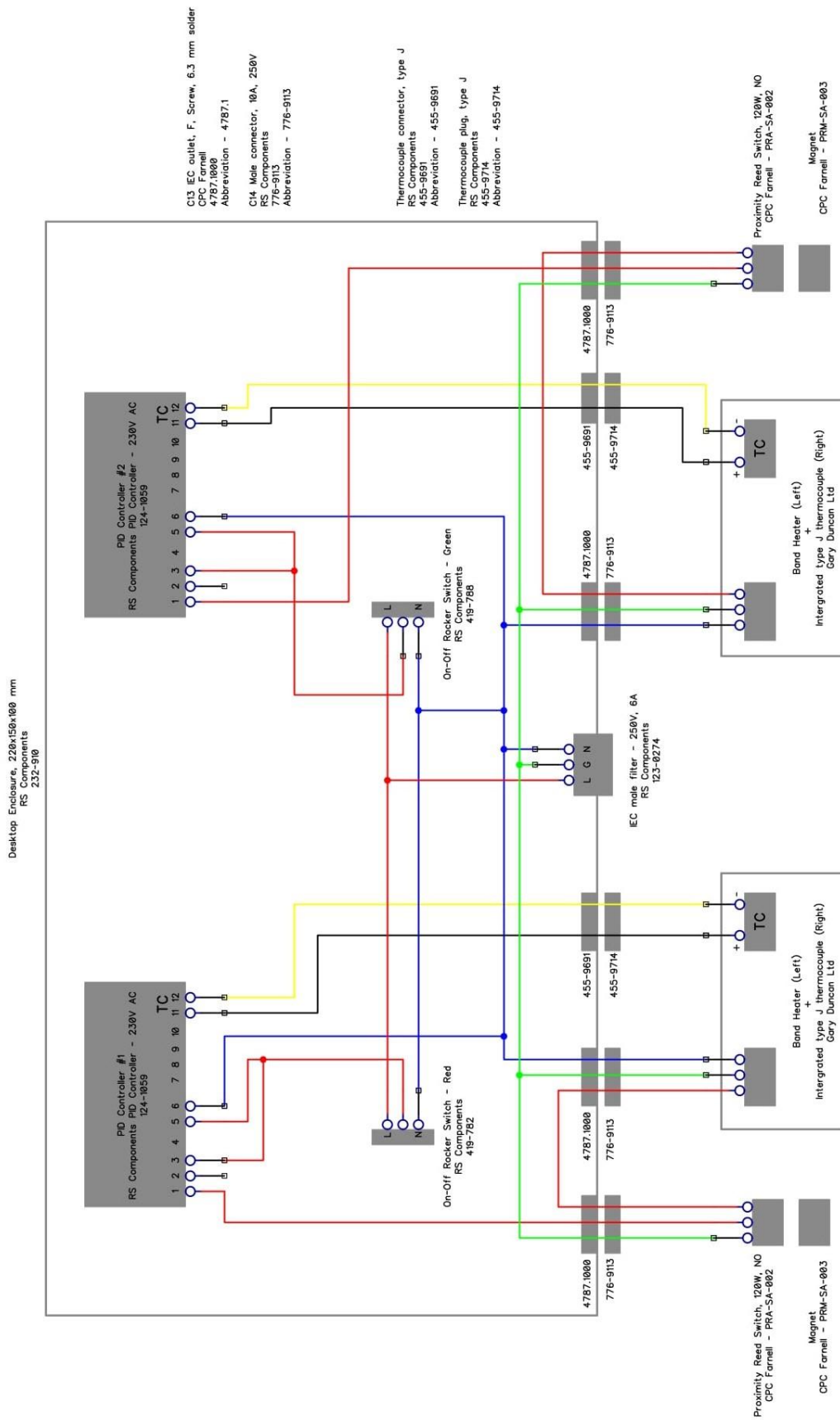

6. Monitoring reaction temperatures

The temperature of the milled reactions (both when ran at room temperature and at elevated temperatures) were monitored over time using a **Lascar Electronics Data Logger** (lascarelectronics.com) attached to a **RS Pro Type K Thermocouple**. The thermocouple was attached to the jars using electrical tape and remained fastened throughout milling. Temperature values were obtained every 1 second over the course of a milling period. These temperature values were verified through use of an IR thermometer (**Testo 830-T1**) on the outside of the milling jar and also of an opened milling jar just after reaction finished.

Heating profiles - 15 mL jar vs. 30 mL jar. To the relevant stainless steel milling jar was added a 3 g stainless steel ball, 1-naphthyl dimethylsulfamate (0.5 mmol), 4-fluorophenyl boronic acid (0.75 mmol), $\text{NiCl}_2(\text{PPh}_3)_2$ (10 mol%), sodium chloride (2 mass equiv.), hexanol (0.122 $\mu\text{L}/\text{mg}$) and tripotassium phosphate (1.5 mmol). The jar was then milled at 30 Hz for 4 hours and the temperature monitored over time. Darker lines in graph below shows a 25 second moving average for clarity. Original values are shown in pastel colours.

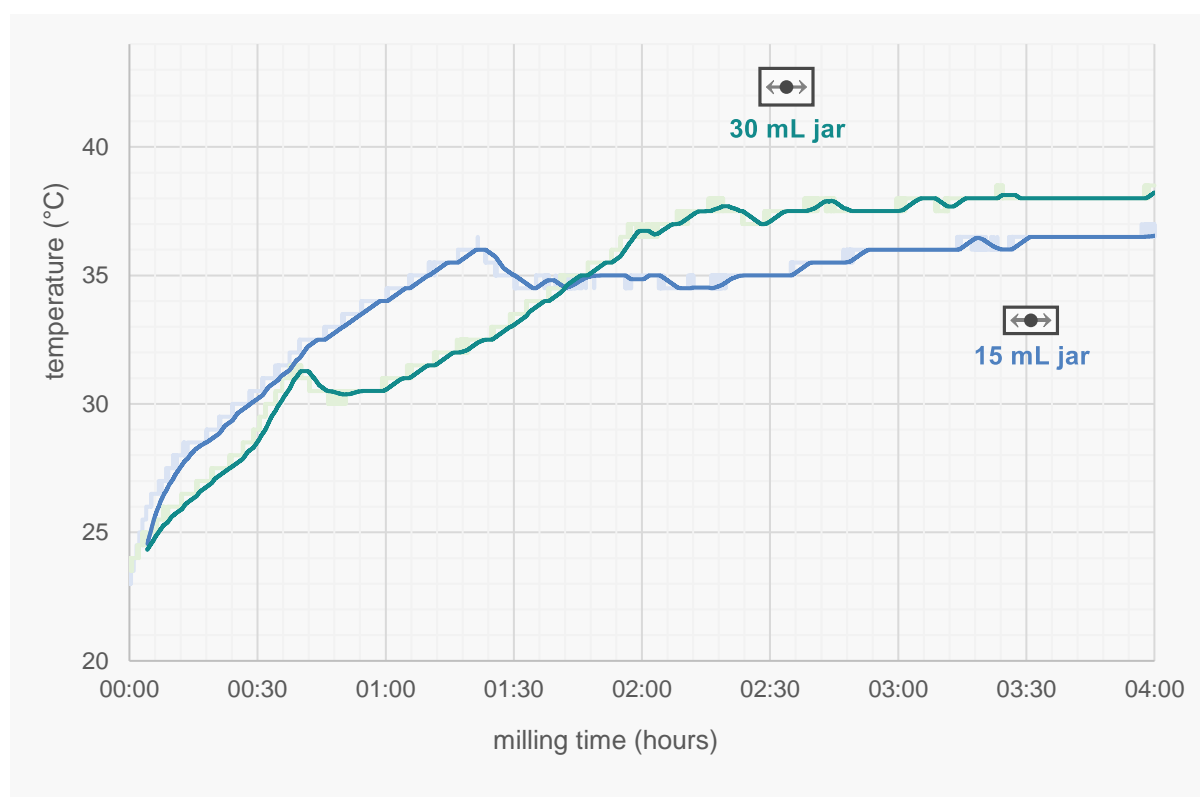

Figure S1: Temperature monitoring studies using different sized jars

Heating profiles – Heat-Gun vs. Jar Heaters. To the relevant stainless steel milling jar was added a 3 g stainless steel ball, 1-naphthyl dimethylsulfamate (0.5 mmol), 4-fluorophenyl boronic acid (0.75 mmol), $\text{NiCl}_2(\text{PPh}_3)_2$ (10 mol%), sodium chloride (2 mass equiv.), hexanol (0.122 $\mu\text{L}/\text{mg}$) and tripotassium phosphate (1.5 mmol). Using either the heat-gun set-up or the jar heater set-up, the jar was then milled at 30 Hz for 30 minutes and the temperature monitored over time. As the jar heater can overshoot – manual oversight of the temperature by stopping the temperature increase about 5 degrees below the target and then pressing heat again – can lead to a more accurate reaction profile (shown in blue). This latter process was used throughout the subsequent reaction development. Darker lines in the graph below shows a 25 second moving average for clarity. Original values are shown in pastel colours.

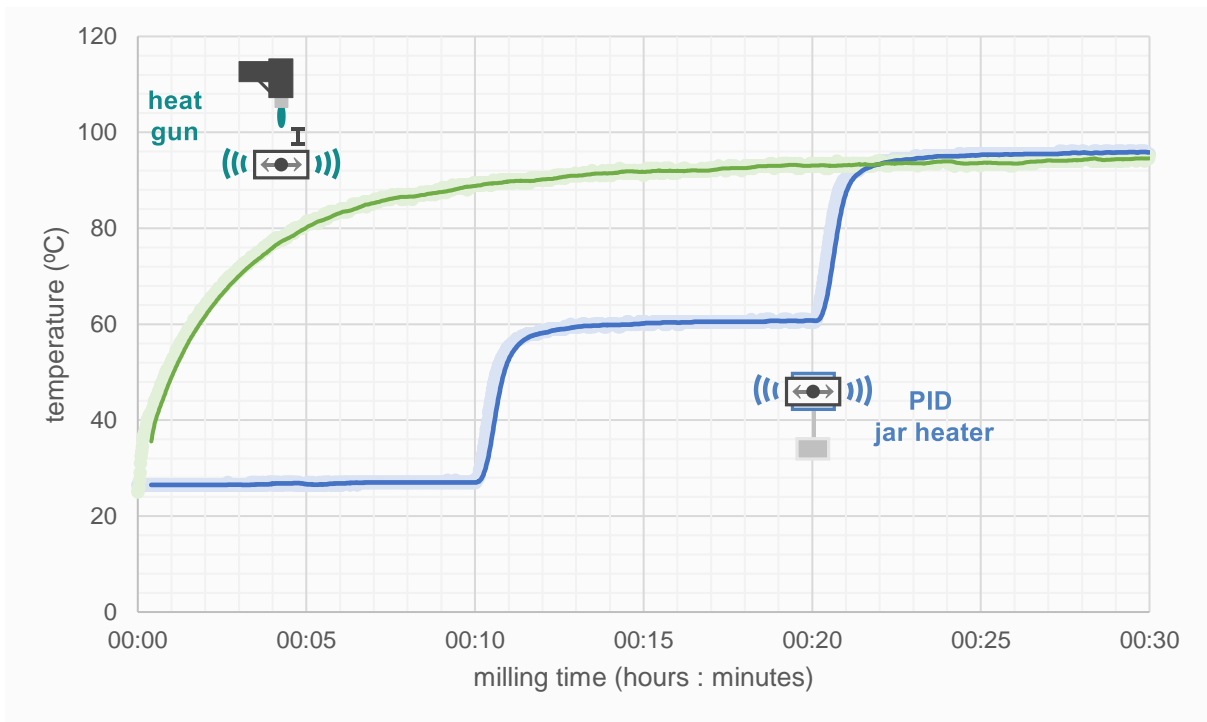

Figure S2: Temperature monitoring studies using different heating methods

7. Further experiments

Table S4: Reactions run in triplicate and quadruplicate to explore reproducibility

Entry	Substrate	End Temp	Run 1	Run 2	Run 3	Run 4	Average Yield	SD
1	3l	110	53	65	51	N/A	56	6
2	3c	120	63	62	69	68	66	3

Table S5: Varying jar size with a variety of ball sizes using the jar heater protocol and hexanol as LAG

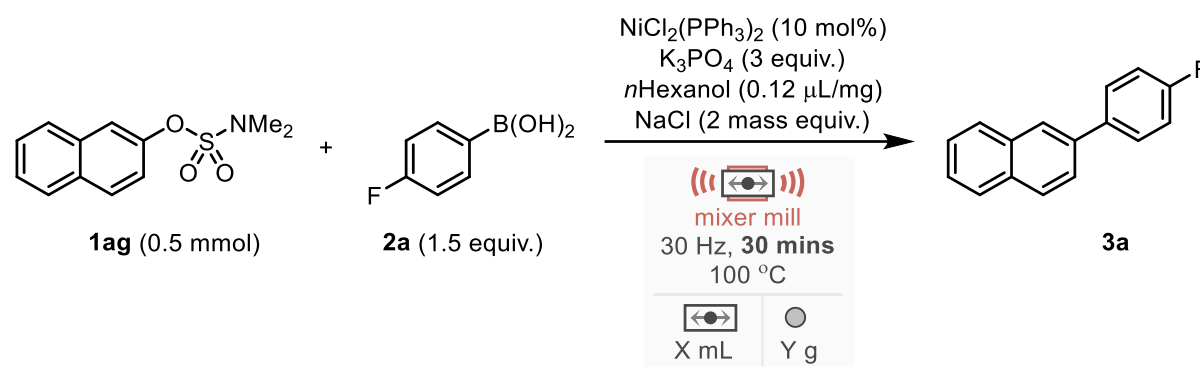

Entry	Jar size (X)	Ball Size (Y)	NMR Yield
1	30 mL	3 g	96%
2	15 mL	2 g	87%
3	15 mL	1 g	93%

Table S6: Varying jar size with a variety of ball sizes using the room temperature protocol and hexanol as LAG

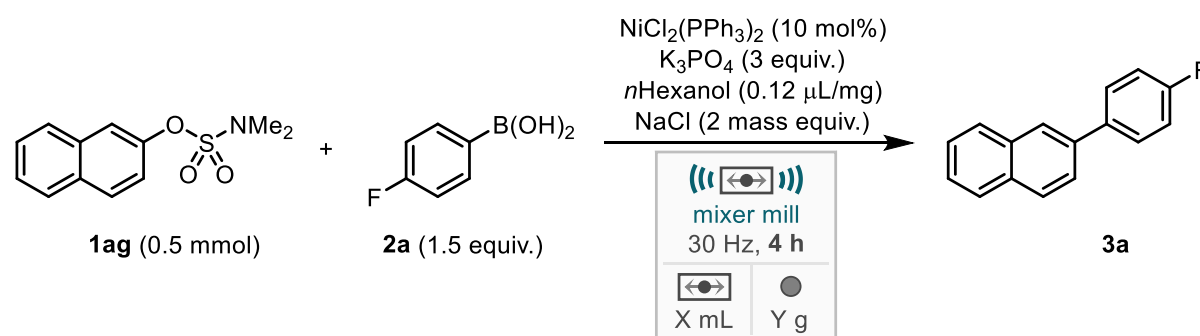

Entry	Jar size (X)	Ball Size (Y)	NMR Yield
1	30 mL	3 g	85%
2	15 mL	2 g	54%
3	15 mL	1 g	55%

30 ml \rightarrow 15 ml jar is 0.5, 3 g ball to 1.5 g ball however we only have 1 g and 2 g milling balls so both were used for comparison

8. Variable temperature experiments using HP2

Starting with electron rich 4-methoxyphenyl boronic acid (**2c**), a steady increase was observed culminating in highest yields at 130 °C. It should be noted that (along with **2b** and **2d**) no reaction occurred without the addition of heat, at either 30 mins or 4-hour reaction time. The well-studied electron neutral 4-fluorophenyl boronic acid (**2a**) showed excellent reactivity at all studied temperatures with those between 90 °C and 120 °C resulting in the greatest yields. Interestingly in this case, further heating to 130 °C resulted in a decreased yield of 85%. Proceeding to electron poor boronic acids bearing CO₂Et (**2d**) and CF₃ (**2e**) similar good reactivity was observed throughout the temperature range, with optimal points at 120 °C and 100 °C respectively.

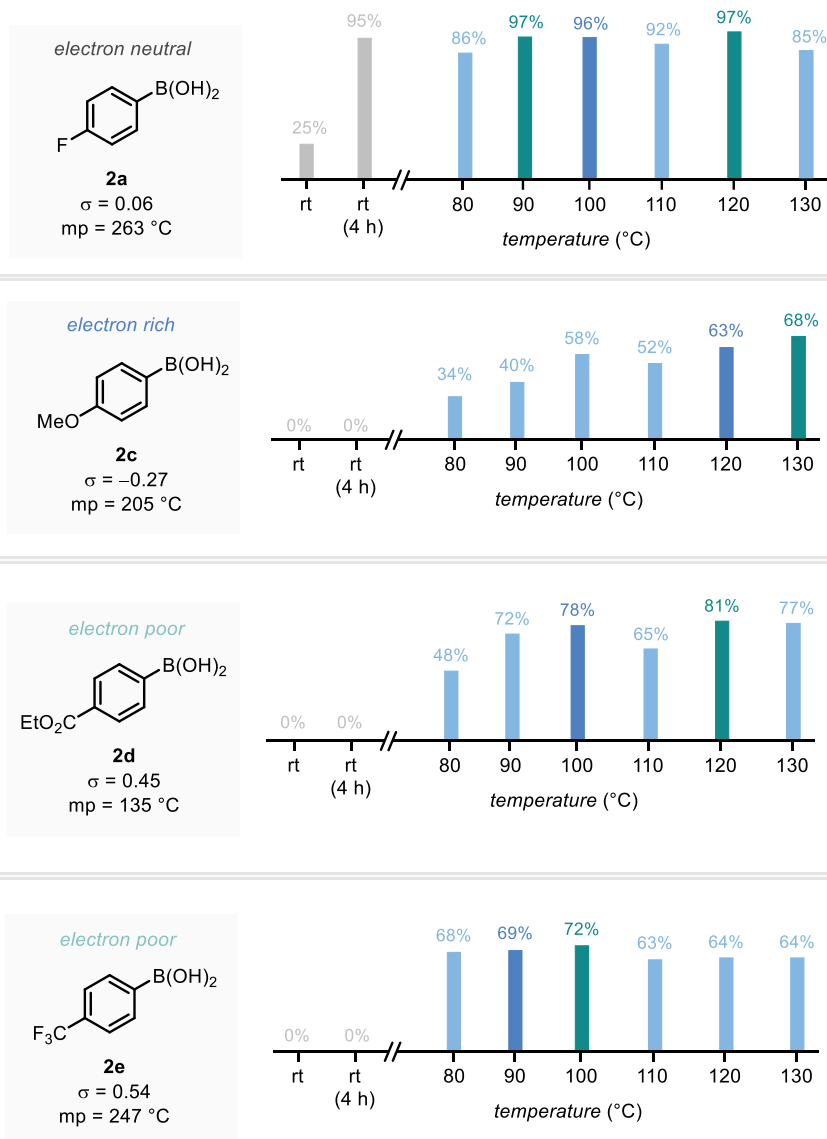

Scheme S1: Temperature variations using a variety of electronically-diverse boronic acid species including control experiments at room temperature

The consistent drop in yield at 110 °C across this study is suggested to be linked to a phase change in the sulfamate starting material which has a melting point of 71-74 °C. The use of 110 °C goes through a mid point temperature of 68 °C (for 10 minutes during HP2) whereas the alternative temperatures (higher than this) result in a mid point above or below this. To assess this finding the 110 °C reaction was conducted again for **1ag** and **2d** with a mid point of 73 °C. In so doing, the yield moderately increased from 65% to 75% demonstrating the importance of the phase change.

9. Sustainability Metrics

9.1: Process Mass Intensity (PMI) calculations

$$PMI_{reaction} = \frac{\text{Total mass of step}}{\text{Mass of product}}$$

Milled reactions

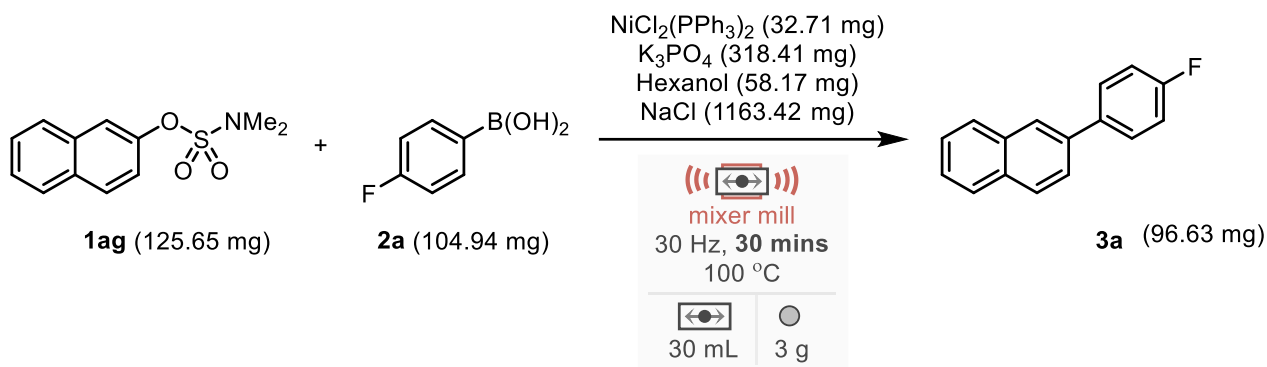

$$PMI_{reaction} = \frac{125.65 + 104.94 + 32.71 + 318.41 + 58.17 + 1163.42}{96.63} = 18.66$$

Extruded reactions

50 mmol

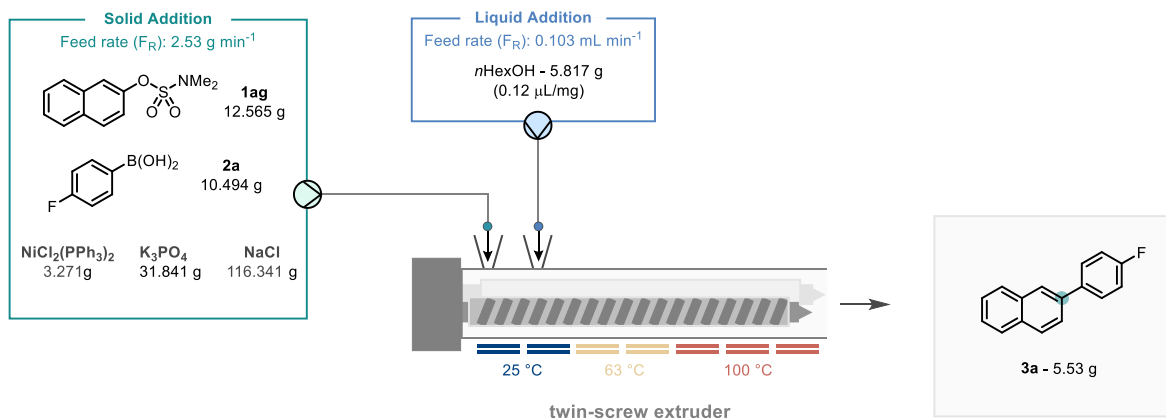

$$PMI_{reaction} = \frac{12.565 + 10.494 + 3.271 + 31.841 + 116.341 + 5.815}{5.53} = 32.60969851$$

100 mmol

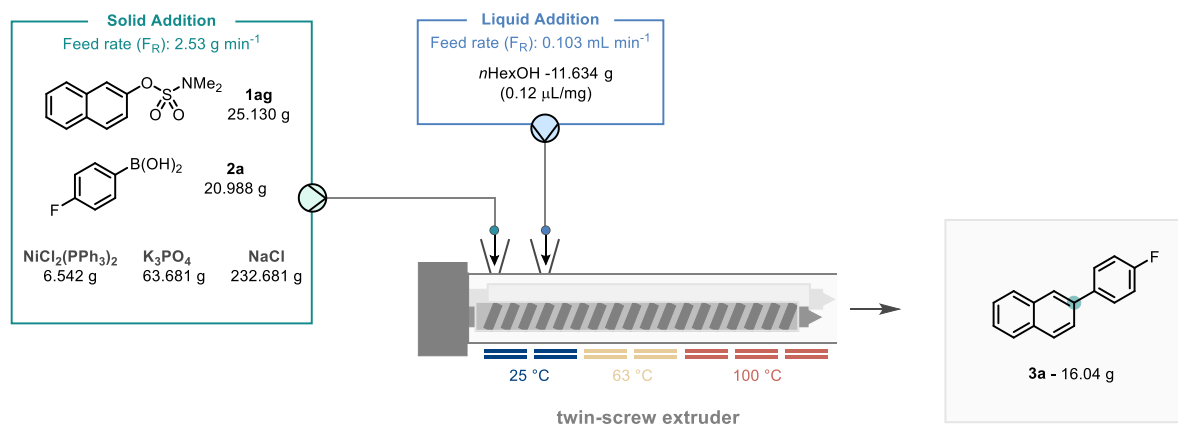

$$PMI_{reaction} = \frac{25.130 + 20.988 + 6.542 + 63.681 + 11.634 + 232.681}{16.04} = 21.760$$

9.2: E-factor calculations

$$E \text{ factor} = \frac{\text{mass of input} - \text{mass of product}}{\text{mass of product}}$$

Milled reaction

$$E \text{ factor} = \frac{(125.65 + 104.94 + 32.71 + 318.41 + 58.17 + 1163.42) - 96.63}{96.63} = 17.66191659$$

Extruded reactions

50 mmol

$$E \text{ factor} = \frac{(12.565 + 10.494 + 3.271 + 31.841 + 116.341 + 5.815) - 5.53}{5.53} = 31.6096985$$

100 mmol

$$E \text{ factor} = \frac{(25.13 + 20.99 + 6.54 + 63.68 + 11.634 + 232.68) - 16.04}{16.04} = 21.49$$

9.3: Space time yield (STY) calculations

$$STY (kg\ days^{-1}m^{-3}) = \frac{\text{mass of product (kg)}}{\text{duration of reaction (days)} \times \text{volume of reactor}(m^3)}$$

50 mmol extrusion

$$STY_{overall} = \frac{0.00553}{0.048611111 \times 0.00003542} = 3211.74\ kg\ days^{-1}m^{-3}$$

100 mmol extrusion

$$STY_{steady\ state} = \frac{0.01067}{0.0625 \times 0.00003542} = 4819.87\ kg\ days^{-1}m^{-3}$$

$$STY_{overall} = \frac{0.01604}{0.125 \times 0.00003542} = 3622.81\ kg\ days^{-1}m^{-3}$$

10: Extrusion protocols

The large-scale extrusion protocols were carried out using a Thermo Scientific™ Process 11 Twin-screw Extruder (TSE) with 7 controllable heating sections.

General Extrusion Procedure

To a large beaker was added 2-naphthalene sulfamate (1 equiv.), 4-fluorophenyl boronic acid (1.5 equiv.), $\text{NiCl}_2(\text{PPh}_3)_2$ (10 mol%), sodium chloride (2 mass equiv.) and K_3PO_4 (3 equivs.). The mixture was mixed by hand using a spatula. The pre-mixed mixture was added to the gravimetric hopper situated at the first port (**Main Feed**, Figure S2) with a feed rate of 2.52 g min^{-1} – calibrated *ex situ*. Hexanol (0.1 volume equiv.) was added via syringe pump through the second port (**Liquid feeding**) at a rate of $0.103 \text{ mL min}^{-1}$

The TSE was set at 50 rpm and each of the twin-screw extruder seven heating zones were heated to the correct temperature (2 x 25 °C, 2 x 63 °C, 3 x 100 °C).

The screw configuration was arranged as shown below in Figure S2.

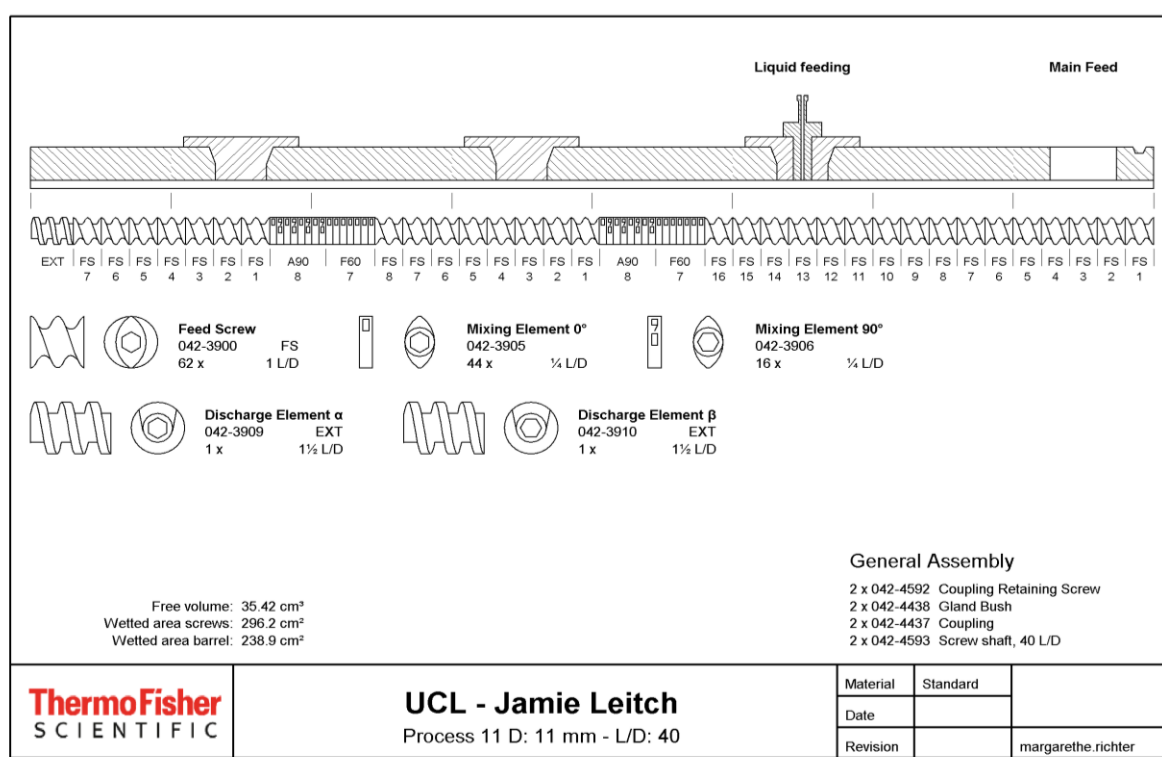
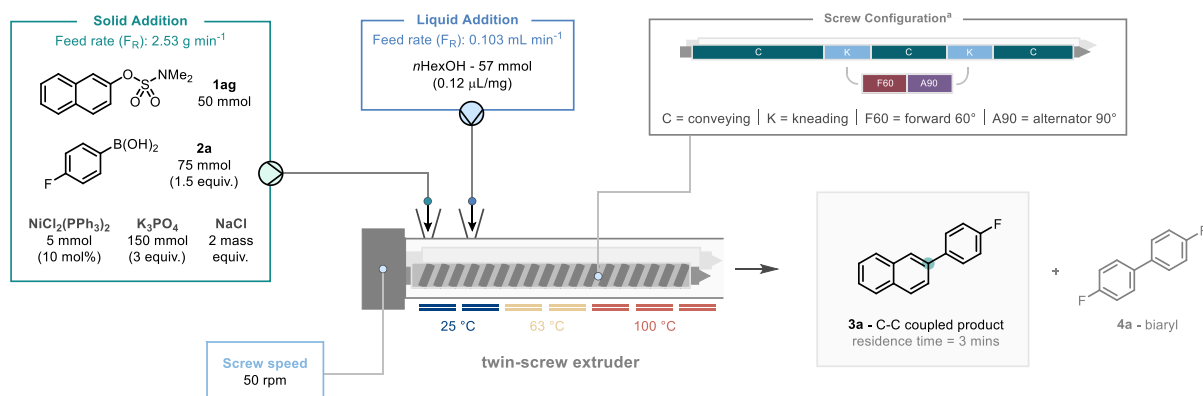

Figure S2: Screw configuration utilised in this process, provided by Thermo Fisher Scientific

The reaction mixture came out of the twin-screw extruder and was collected in a beaker filled with water ($\approx 40 \text{ mL}$) at 10-minute intervals. Each beaker was added to a separating funnel and ethyl acetate added. The reaction mixture was then washed with 1.1 M NaOH, water and brine, dried over magnesium sulfate and concentrated *in vacuo* to give the crude reaction mixture.

The resulting crude residue was purified by silica gel flash column chromatography using hexane to give the pure product unless stated otherwise.

50 mmol reaction



2-naphthalene sulfamate (12.565 g, 50 mmol, 1 equiv.), 4-fluorophenyl boronic acid (10.494 g, 75 mmol, 1.5 equiv.), $\text{NiCl}_2(\text{PPh}_3)_2$ (3.271 g, 2.5 mmol, 10 mol%), K_3PO_4 (31.841 g, 150 mmol, 3 equiv.) and sodium chloride (116.341 g, 2 mass equiv.) were added to the large beaker and the mixture was mixed by hand using a spatula and added to a gravimetric single screw feeder.

Hexanol (7.146 mL, 57 mmol, 0.1 volume equiv.) was added via syringe pump through the second port at a rate of $0.103 \text{ mL min}^{-1}$

Table S7: Results from the 50 mmol extrusion protocol. Yields given are NMR yields calculated vs. mmol min^{-1} starting material input against mesitylene as an internal standard

Time (mins)	Product Yield	Starting material yield	Biphenyl yield	Conversion (P+SM+B)
0	0%	0%	0%	0%
10	23%	20%	2%	45%
20	52%	1%	6%	59%
30	61%	0%	5%	66%
40	62%	0%	5%	67%
50	59%	0%	6%	65%
60	73%	10%	6%	89%
70	15%	9%	7%	31%

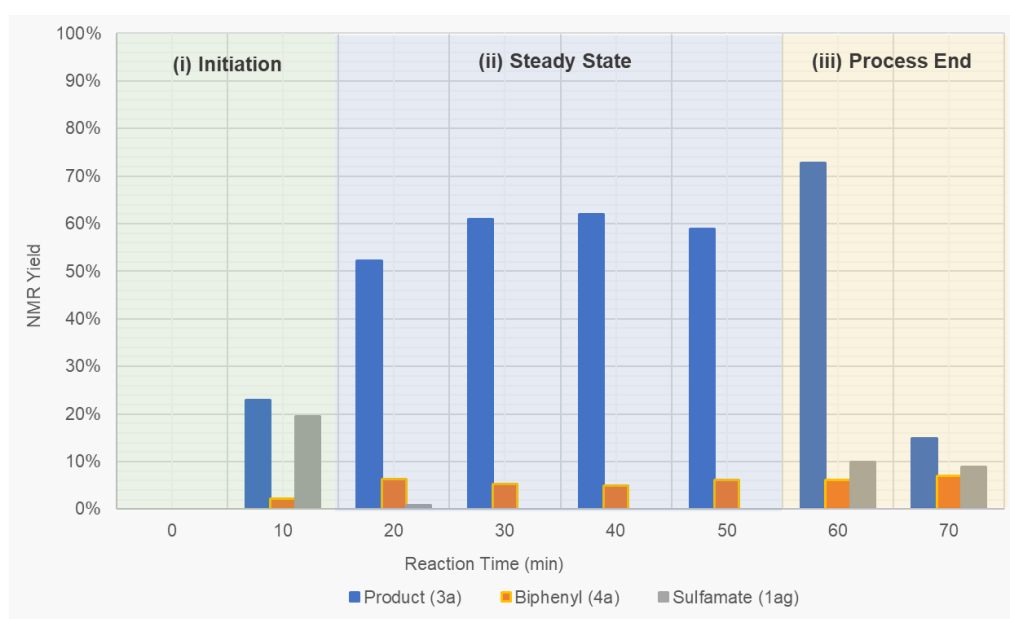

Figure S3. Results from 50 mmol reaction

100 mmol reaction

2-naphthalene sulfamate (25.130 g, 100 mmol, 1 equiv.), 4-fluorophenyl boronic acid (20.988 g, 150 mmol, 1.5 equiv.), $\text{NiCl}_2(\text{PPh}_3)_2$ (6.542 g, 5 mmol, 10 mol%), K_3PO_4 (63.681 g, 300 mmol, 3 equiv.) and sodium chloride (232.681 g, 2 mass equiv.) were added to the large beaker and the mixture was mixed by hand using a spatula and added to a gravimetric single screw feeder.*

Hexanol (14.3 mL, 114 mmol, 0.1 volume equiv.) was added via syringe pump through the second port at a rate of $0.103 \text{ mL min}^{-1}$.

Material started appearing at the end of the extruder after ~ 3 minutes and torque values between 1.8 and 3.2 Nm were maintained throughout the process.

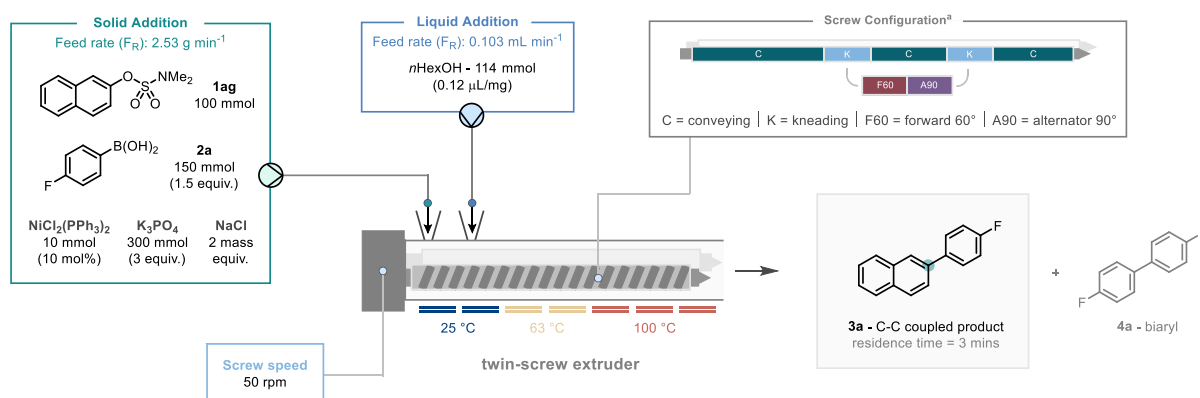

*Sodium chloride and K_3PO_4 were both dried in $175 \text{ }^\circ\text{C}$ oven for approximately 3 hours prior to use

Table S8: Results from the 100 mmol extrusion protocol. Yields given are NMR yields calculated vs. mmol min^{-1} starting material input against mesitylene as an internal standard

Time (mins)	Product Yield	Starting material yield	Biphenyl yield	Conversion (P+SM+B)
0	0%	0%	0%	0%
10	20%	20%	1%	41%
20	46%	1%	3%	51%
30	42%	1%	2%	45%
40	46%	0%	3%	49%
50	49%	0%	3%	52%
60	71%	3%	5%	79%
70	60%	0%	4%	63%
80	74%	3%	4%	81%
90	71%	0%	4%	76%
100	75%	5%	5%	84%
110	63%	1%	5%	69%
120	89%	1%	4%	95%
130	81%	1%	4%	87%
140	81%	1%	4%	86%
150	52%	10%	4%	66%
160	37%	19%	3%	58%
170	36%	2%	3%	40%
180	8%	2%	1%	10%

*150g of NaCl was added at 140 minutes and the screw speed was increased from 50 rpm to 100 rpm at 150 minutes as torque values of over 4.0 Nm were recorded.

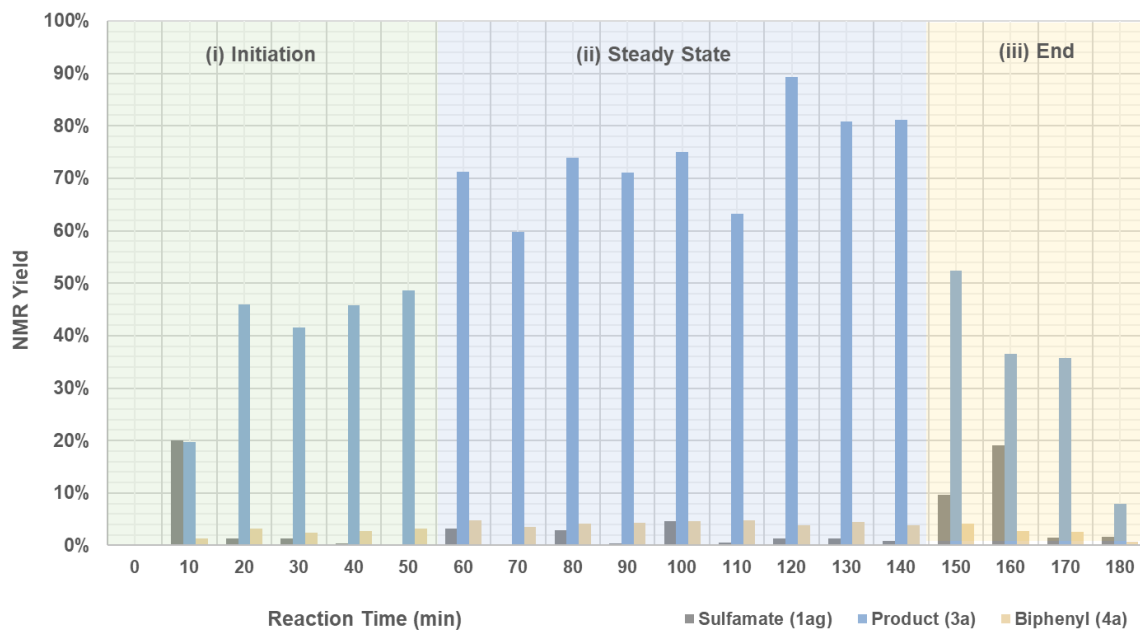

Figure S4. Results from 100 mmol reaction

Fractions from (ii) Steady state were combined and purified *via* silica gel column chromatography to give pure product **3a**. (i) Initiation and (ii) End were also combined together and purified *via* silica gel column chromatography. The two pots of material were combined together to give the overall isolated yield, 13.76 g (62%).

11. Experimental procedures

11.1 Synthesis of starting materials

11.1.1. Procedures for other activated phenol starting materials

2-Naphthyl pivalate (1aa)

Prepared according to modified literature.^[1] To an oven dried round bottom flask equipped with a stirring bar, alcohol (1 equiv.), NEt₃ (1.1 equiv.), DMAP (10 mol%) and DCM was added. Pivaloyl chloride (1.1 equiv.) was added dropwise, and the reaction stirred until effervescence subsided.

The reaction was washed with NaHSO₄ and the aqueous layer extracted with DCM (3 x 25 mL). The combined organic layers were washed with brine (3 x 25 mL) and dried over magnesium sulfate. The solvent was evaporated to give the crude product.

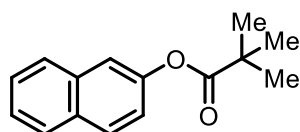

The crude product was purified by flash column chromatography to afford **2-Naphthyl pivalate** (1.10 g, 98%) as a white solid. **mp**: 66–68 °C. **¹H NMR** (500 MHz, CDCl₃) δ 7.89 – 7.82 (m, 2H), 7.82 – 7.77 (m, 1H), 7.56 – 7.52 (d, *J* = 2.3 Hz, 1H), 7.52 – 7.43 (m, 2H), 7.23 – 7.17 (dd, *J* = 8.8, 2.3 Hz, 1H), 1.43 – 1.39 (s, 9H) ppm. **¹³C NMR** (126 MHz, CDCl₃) δ 177.4, 148.9, 133.9, 131.5, 129.5, 127.9, 127.7, 126.6, 125.7, 121.3, 118.5, 39.3, 27.3 ppm.

This data is consistent with the literature.^[1]

tert-Butyl 2-naphthyl carbonate (1ab)

Prepared according to modified literature.^[2] To an oven dried round bottom flask equipped with a stirring bar, alcohol (1 equiv.), NEt₃ (1.1 equiv.), DMAP (10 mol%) and DCM were added. Boc₂O (1.1 equiv.) was added dropwise, and the reaction stirred until effervescence subsided.

The reaction was washed with NaHSO₄ and the aqueous layer extracted with DCM (3 x 25 mL). The combined organic layers were washed with brine (3 x 25 mL) and dried over magnesium sulfate. The solvent was evaporated to give the crude product.

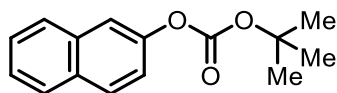

The crude product was purified by flash column chromatography to afford ***tert*-Butyl 2-naphthyl carbonate** (1.06 g, 87%) as a white solid. **mp**: 73–75 °C. **¹H NMR** (500 MHz, CDCl₃) δ 7.90 – 7.78 (ddd, *J* = 13.5, 8.6, 6.4 Hz 3H), 7.68 – 7.62 (d, *J* = 2.5 Hz, 1H), 7.53 – 7.42 (m, 2H), 7.35 – 7.29 (dt, *J* = 8.8, 1.8 Hz, 1H), 1.62 – 1.57 (s, 9H) ppm. **¹³C NMR** (126 MHz, CDCl₃) δ 152.1, 148.8, 133.8, 131.5, 129.5, 127.9, 127.8, 126.7, 125.8, 121.0, 118.3, 83.8, 27.9 ppm.

This data is consistent with the literature.^[2]

2-Naphthyl diethylcarbamate (1ac)

Prepared according to modified literature.^[2] To an oven dried round bottom flask equipped with a stirring bar, sodium hydride (60% paraffin oil) was added under argon. The flask was cooled to 0 °C and the alcohol (1 equiv.) in 1 M dry THF was added over 10 minutes. The reaction mixture was then stirred at rt. For 10 minutes. The reaction mixture was then cooled to 0 °C and Diethyl carbonyl chloride (1.2 equiv.) was added over 10 minutes. The reaction was left to stir overnight.

The reaction was quenched with water. Ether was added and the solution washed with 1.1 M NaOH (25 mL) and water (3 x 25 mL). The combined aqueous layers were then extracted with ether. The combined organic layers were washed with brine (3 x 25 mL) and dried over magnesium sulfate. The solvent was evaporated to give the crude product.

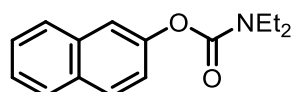

The crude product was purified by flash column chromatography to afford **2-Naphthyl diethylcarbamate** (2.16 g, 90%) as a pale-yellow oil. ¹H NMR (500 MHz, CDCl₃) δ 7.87 – 7.81 (m, 2H), 7.81 – 7.77 (dd, *J* = 8.1, 1.4 Hz, 1H), 7.61 – 7.57 (d, *J* = 2.3 Hz, 1H), 7.50 – 7.41 (dddd, *J* = 16.6, 8.2, 6.8, 1.4 Hz, 2H), 7.31 – 7.27 (dd, *J* = 8.8, 2.4 Hz, 1H), 3.57 - 3.37 (m, 4H), 1.35 – 1.20 (m, 6H) ppm. ¹³C NMR (126 MHz, CDCl₃) δ 154.5, 149.3, 134.0, 131.3, 129.2, 127.8, 127.7, 126.4, 125.4, 121.8, 118.5, 42.4, 42.1, 14.4, 13.6 ppm.

This data is consistent with the literature. ^[2]

2-Naphthyl triflate (1ad)

Prepared according to modified literature.^[3] To round bottom flask equipped with a stirring bar, alcohol (1 equiv.), pyridine (1.2 equiv.) and dry DCM were added. The flask was cooled to 0 °C and Tf₂O (1.5 equiv.) was added dropwise. The reaction was warmed to RT and left to stir overnight.

The reaction was saturated with NaHCO₃ (25 mL). The aqueous phase was washed with DCM (3 x 25 mL) and dried over magnesium sulfate. The solvent was evaporated to give the crude product.

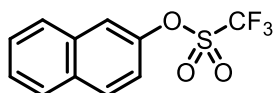

The crude product was purified by flash column chromatography to afford **2-Naphthyl triflate** (1.24 g, 90%) as a white solid. mp: 31–33 °C. ¹H NMR (500 MHz, CDCl₃) δ 7.97 – 7.85 (m, 3H), 7.79 – 7.74 (d, *J* = 2.5 Hz, 1H), 7.63 – 7.55 (td, *J* = 6.7, 3.7 Hz, 2H), 7.42 – 7.36 (dd, *J* = 9.0, 2.5 Hz, 1H) ppm. ¹³C NMR (126 MHz, CDCl₃) δ 147.2, 133.5, 132.5, 130.8, 128.2, 128.1, 127.7, 127.3, 119.7, 119.4, 119.0 (q, *J* = 321 Hz) ppm.

This data is consistent with the literature. ^[4]

2-Naphthyl tosylate (1ae)

Prepared according to modified literature.^[5] To round bottom flask equipped with a stirring bar, alcohol (1 equiv.), NEt₃ (1.5 equiv.), DMAP (20 mol%) and DCM were added. The reaction was cooled to 0 °C and TsCl (1.2 equiv.) in DCM was added dropwise and left to stir for 2 hours.

The reaction was quenched with DCM (3 x 25 mL) and the combined organic layers washed with brine (3 x 25 mL) and dried over magnesium sulfate. The solvent was evaporated to give the crude product.

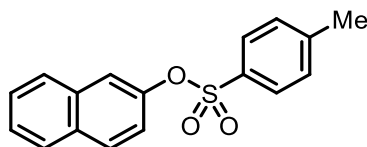

The crude product was purified by flash column chromatography to afford **2-Naphthyl tosylate** (1.28 g, 86%) as a white solid. **mp**: 125–127 °C. **¹H NMR** (500 MHz, CDCl₃) δ 7.85 – 7.78 (m, 1H), 7.78 – 7.71 (m, 4H), 7.54 – 7.45 (m, 3H), 7.33 – 7.27 (d, *J* = 8.1, 1H), 7.12 – 7.07 (dd, *J* = 8.9, 2.4 Hz, 1H), 2.47 – 2.42 (s, 3H) ppm. **¹³C NMR** (126 MHz, CDCl₃) δ 147.3, 145.5, 133.5, 132.5, 132.0, 129.9, 129.9, 128.7, 128.0, 127.9, 127.0, 126.5, 121.3, 120.1, 21.9 ppm.

This data is consistent with the literature.^[6]

2-Naphthyl mesylate (1af)

Prepared according to modified literature.^[7] To an oven dried round bottom flask equipped with a stirring bar, alcohol (1 equiv.), dry pyridine (5 equiv.) and dry DCM were added, and the flask was cooled to 0 °C. Methane sulfonyl chloride (1.2 equiv.) was added dropwise. The reaction was warmed to RT and left to stir overnight.

The reaction was quenched with water. The aqueous layer was washed with DCM (3 x 25 mL). The combined organic layers were washed with 15% HCl (25 mL), brine (3 x 25 mL) and then dried over magnesium sulfate. The solvent was evaporated to give the crude product.

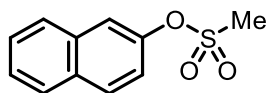

The crude product was purified by recrystallisation (Hexane: DCM) to afford **2-Naphthyl mesylate** (506 mg, 45%) as a pink solid. **mp**: 107–109 °C. **¹H NMR** (500 MHz, CDCl₃) δ 7.94 – 7.83 (m, 3H), 7.79 – 7.75 (d, *J* = 2.4 Hz, 1H), 7.58 – 7.50 (m, 2H), 7.44 – 7.39 (dd, *J* = 8.9, 2.4 Hz, 1H), 3.21 – 3.18 (s, 3H) ppm. **¹³C NMR** (126 MHz, CDCl₃) δ 146.9, 133.7, 132.2, 130.5, 128.0, 128.0, 127.3, 126.8, 120.9, 119.6, 37.6 ppm.

This data is consistent with the literature.^[6]

11.1.2. General Procedure A: Synthesis of aryl sulfamates

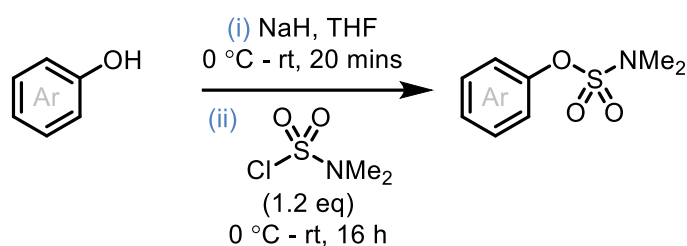

Prepared according to modified literature (Reference).^[8] To an oven dried round bottom flask equipped with a stirring bar, sodium hydride (60% paraffin oil) was added under argon. The flask was cooled to 0 °C and the alcohol (1 equiv.) in 1 M dry THF was added over 10 minutes. The reaction mixture was then stirred at rt. For 10 minutes. The reaction mixture was then cooled to 0 °C and *N,N*-Dimethylsulfamoyl chloride (1.2 equiv.) was added over 10 minutes. The reaction was left to stir overnight.

The reaction was quenched with water. Ether was added and the solution washed with 1.1 M NaOH (25 mL) and water (3 x 25 mL). The combined aqueous layers were then extracted with ether. The combined organic layers were washed with brine (3 x 25 mL) and dried over magnesium sulfate. The solvent was evaporated to give the crude product.

This was then purified by flash column chromatography to give the pure product.

2-Naphthyl dimethylsulfamate (1ag)

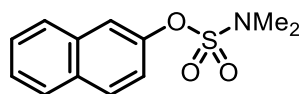

Prepared according to general procedure **A**. Purified by flash column chromatography (Hexane: DCM, 1:1) to give **2-Naphthyl dimethylsulfamate** (2.23 g, 89%) as a pale-yellow solid. **mp**: 71–74 °C **¹H NMR** (500 MHz, CDCl₃) δ 7.90 – 7.82 (m, 3H), 7.76 (d, *J* = 2.3 Hz, 1H), 7.56 – 7.47 (m, 2H), 7.42 (dd, *J* = 8.9, 2.4 Hz, 1H), 3.03 – 2.99 (s, 6 H) ppm. **¹³C NMR** (126 MHz, CDCl₃) δ 147.9, 133.8, 131.9, 130.1, 128.0, 127.9, 127.1, 126.4, 120.9, 119.2, 39.0 ppm.

This data is consistent with the literature.^[8]

1-Naphthyl dimethylsulfamate (1b)

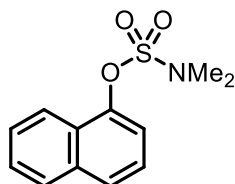

Prepared according to general procedure **A**. Purified by flash column chromatography (Hexane: DCM, 1:1) to give **1-Naphthyl dimethylsulfamate** (530 mg, 84%) as a white solid. **mp**: 76–77 °C **¹H NMR** (500 MHz, CDCl₃) δ 8.18 (dd, *J* = 8.3, 1.3 Hz, 1H), 7.88 (dd, *J* = 8.5, 1.2 Hz, 1H), 7.81 – 7.76 (m, 1H), 7.46 (t, *J* = 7.9 Hz, 1H), 3.08 – 3.06 (s, 6 H) ppm. **¹³C NMR** (126 MHz, CDCl₃) δ 146.2, 135.0, 128.1, 127.3, 126.9, 126.8, 125.5, 121.6, 117.9, 39.1 ppm.

This data is consistent with the literature.^[9]

4-Phenylphenyl dimethylsulfamate (1c)

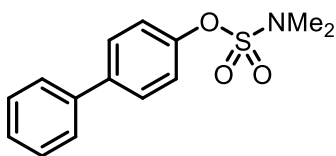

Prepared according to general procedure **A**. Purified by flash column chromatography (Hexane: Ethyl Acetate, 100:0 - 80:20 v:v) to give **4-Phenylphenyl dimethylsulfamate** (577 mg, 83%) as a white solid. **mp**: 114–117 °C **¹H NMR** (500 MHz, CDCl₃) δ 7.60 (d, *J* = 8.7 Hz, 2H), 7.58 – 7.55 (m, 2H), 7.45 (dd, *J* = 8.4, 6.9 Hz, 2H), 7.39 – 7.34 (m, 3H), 3.03 – 3.00 (s, 6H) ppm. **¹³C NMR** (126 MHz, CDCl₃) δ 149.7, 140.1, 140.1, 129.0, 128.6, 127.7, 127.3, 122.2, 39.0 ppm.

This data is consistent with the literature.^[10]

4-Methoxy-1-naphthyl dimethylsulfamate (1d)

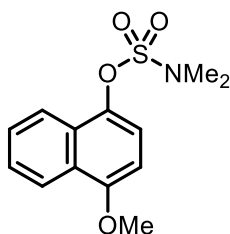

Prepared according to general procedure **A**. Purified by flash column chromatography (Hexane: Ethyl Acetate, 100:0 - 85:15 v:v) to give **4-Methoxy-1-naphthyl dimethylsulfamate** (457 mg, 65%) as a light brown solid. **mp**: 78–80 °C. **¹H NMR** (500 MHz, CDCl₃) δ 8.27 (d, *J* = 8.4 Hz, 1H), 8.10 (d, *J* = 8.3 Hz, 1H), 7.56 (dddd, *J* = 31.5, 8.3, 6.8, 1.3 Hz, 2H), 7.44 (d, *J* = 8.4 Hz, 1H), 6.75 (d, *J* = 8.4 Hz, 1H), 4.05 – 3.97 (s, 3H), 3.06 – 3.02 (s, 3H) ppm. **¹³C NMR** (126 MHz, CDCl₃) δ 154.1, 139.6, 128.1, 127.4, 126.4, 126.2, 122.5, 121.4, 118.2, 102.8, 55.9, 39.0 ppm.

This data is consistent with the literature.^[2]

4-Methoxyphenyl dimethylsulfamate (1e)

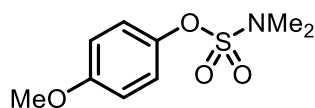

Prepared according to general procedure **A**. Purified by flash column chromatography (Hexane: Ethyl Acetate, 100:0 - 89:11 v:v) to give **4-Methoxyphenyl dimethylsulfamate** (317 mg, 55%) as a colourless oil. **¹H NMR** (500 MHz, CDCl₃) δ 7.20 (d, *J* = 9.0 Hz, 2H), 6.88 (d, *J* = 9.1 Hz, 2H), 3.82 – 3.78 (s, 3H), 2.97 – 2.94 (s, 6H) ppm. **¹³C NMR** (126 MHz, CDCl₃) δ 158.2, 143.7, 123.0, 114.8, 55.8, 38.9 ppm

This data is consistent with the literature.^[2]

4-Cyanophenyl dimethylsulfamate (1f)

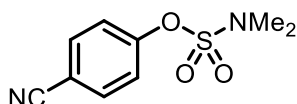

Prepared according to general procedure **A**. Purified by flash column chromatography (Hexane: DCM, 100:0 – 50:50 v:v) to give **4-Cyanophenyl dimethylsulfamate** (377 mg, 67%) as a white solid. **mp**: 71–73 °C **¹H NMR** (400 MHz, CDCl₃) δ 7.71 (d, *J* = 8.7 Hz, 2H), 7.40 (d, *J* = 8.8 Hz, 2H), 3.05 – 2.99 (s, 6 H) ppm. **¹³C NMR** (101 MHz, CDCl₃) δ 153.6, 134.2, 122.6, 118.1, 110.7, 38.9 ppm.

This data is consistent with the literature.^[8]

Methyl-4-hydroxybenzyl dimethylsulfamate (1g)

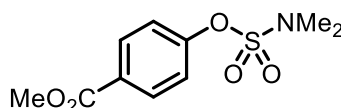

Prepared according to general procedure **A**. Purified by flash column chromatography (Hexane: Ethyl Acetate, 100:0 – 75:25 v:v) to give **Methyl-4-hydroxybenzyl dimethylsulfamate** (359 mg, 55%) as a white solid. **mp**: 71–73 °C. **¹H NMR** (500 MHz, CDCl₃) δ 8.08 (d, *J* = 8.7 Hz, 2H), 7.35 (d, *J* = 8.7 Hz, 2H), 3.94 – 3.91 (s, 3H), 3.02 – 2.99 (s, 6H) ppm. **¹³C NMR** (126 MHz, CDCl₃) δ 166.2, 153.9, 131.7, 128.6, 121.6, 52.5, 38.9 ppm.

This data is consistent with the literature.^[8]

11.1.3. General procedure B: Hydroxyl pyridine dimethylsulfamate synthesis

Prepared according to modified literature.^[11] To an oven dried microwave vial equipped with stirring bar was added hydroxypyridine (1 equiv.) in 1 M pyridine. N,N-Dimethylsulfamoyl chloride (1.2 equiv.) was added over 10 minutes. The reaction was heated to 45 °C and left to stir overnight.

The reaction was cooled to rt. Ether was added and washed with 1.1 M NaOH (25 mL) and the layers separated. The aqueous layers were then extracted with ether (2 x 25 mL) followed by ethyl acetate (25 mL). The combined organic layers were with brine (2 x 25 mL) and dried over magnesium sulfate. The solvent was evaporated to give the crude product.

This was then purified by flash column chromatography to give the pure product.

3-hydroxypyridyl dimethylsulfamate (1h)

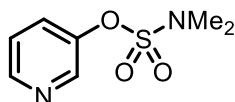

Prepared according to general procedure **B**. Purified by flash column chromatography (Hexane: DCM, 100:0 – 50:50 v:v) to give **3-hydroxypyridyl dimethylsulfamate** (1.62 g, 80%) as a colourless oil. **¹H NMR** (500 MHz, CDCl₃) δ 8.58 – 8.52 (m, 2H), 7.67 (ddd, *J* = 8.5, 2.8, 1.4 Hz, 1H), 7.36 (dd, *J* = 8.4, 4.7

Hz, 1H), 3.03 – 3.00 (s, 6H) ppm. $^{13}\text{C NMR}$ (126 MHz, CDCl_3) δ 148.0, 147.3, 143.8, 129.5, 124.4, 38.9 ppm.

This data is consistent with the literature.^[8]

2-hydroxypyridyl dimethylsulfamate (1i)

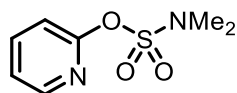

Prepared according to general procedure **B**. Purified by flash column chromatography (Hexane: Ethyl Acetate, 100:0 – 50:50 v:v) to give **2-hydroxypyridyl dimethylsulfamate** (441 mg, 87%) as a colourless oil. $^1\text{H NMR}$ (500 MHz, CDCl_3) δ 8.41 – 8.35 (m, 1H), 7.80 (ddd, $J = 8.2, 7.3, 2.0$ Hz, 1H), 7.25 – 7.23 (m, 1H), 7.19 (dt, $J = 8.2, 0.9$ Hz, 1H), 3.06 - 3.02 (s, 6 H) ppm. $^{13}\text{C NMR}$ (126 MHz, CDCl_3) δ 157.6, 148.4, 140.3, 122.5, 115.5, 38.9 ppm.

This data is consistent with the literature.^[11]

11.2. Synthesis of C-C coupled products

11.2.1. General Procedure C: Mechanochemical nickel-catalysed Suzuki-Miyaura cross coupling

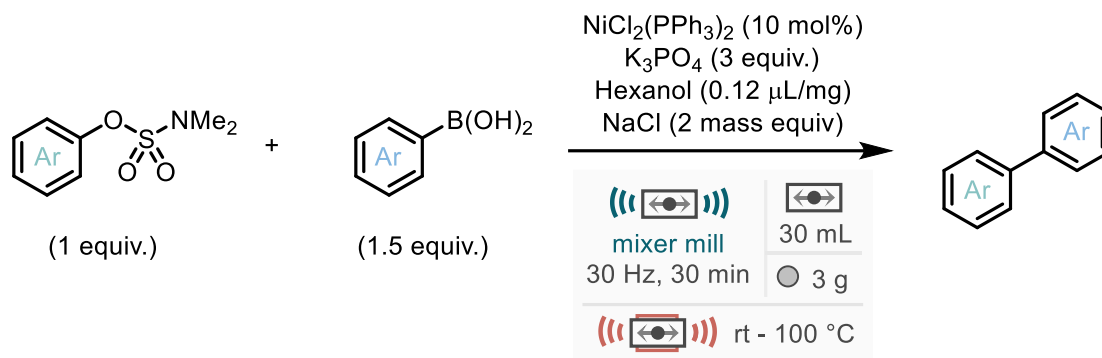

To a 30 mL stainless steel milling jar was added a 3 g stainless steel ball, aryl dimethylsulfamate (0.5 mmol), boronic acid (0.75 mmol), NiCl₂(PPh₃)₂ (10 mol%), sodium chloride (2 mass equiv.), hexanol (0.122 μL/mg) and tripotassium phosphate (1.5 mmol). A band heater encased the jar and milled at 30 Hz for 30 minutes. The first 10 minutes were conducted at rt. With the next 10 minutes heated to 63 °C and the remaining 10 minutes to 100 °C. After this time the milling was stopped, and jar allowed to cool to ~40 °C before further manipulation. The reaction mixture was removed from the jar into a conical flask with ethyl acetate (~30 mL) and water (~30 mL) *. The organic layer was washed with 1.1 M NaOH (25 mL), water (50 mL), brine (50 mL), dried over magnesium sulfate, and concentrated *in vacuo* to give the crude reaction mixture.** The resulting crude residue was purified by silica gel flash column chromatography using hexane/ ethyl acetate solvent system to give the pure product unless stated otherwise.

*a sonicator was used to break up any large pieces

** a dilute H₂O₂ solution (25 mL) was also used for boronic acids containing electron-donating groups to facilitate removal of PPh₃ ligand, which could co-elute with C-C coupled products.

2-(4-fluorophenyl) naphthalene (3a)

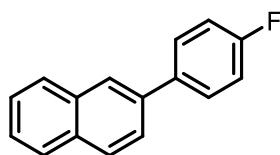

Prepared according to general procedure C. Purified by flash column chromatography (Hexane) to give **2-(4-fluorophenyl) naphthalene** (97 mg, 87%) as a white solid. **mp**: 102–105 °C. **¹H NMR** (400 MHz, CDCl₃) δ 8.00 – 7.89 (s, 1H), 7.89 – 7.76 (m, 3H), 7.70 – 7.53 (m, 3H), 7.53 – 7.38 (m, 2H), 7.20 – 7.02 (m, 2H) ppm. **¹³C NMR** (101 MHz, CDCl₃) δ 162.7 (d, *J* = 246.5 Hz) 137.8, 137.4 (d, *J* = 2.8 Hz) 133.8, 132.7, 129.2 (d, *J* = 8.3 Hz), 128.7, 128.3, 127.8, 126.6, 126.2, 125.8, 125.6, 115.9 (d, *J* = 21.2 Hz) ppm.

This data is consistent with the literature.^[12]

2-phenyl naphthalene (3b)

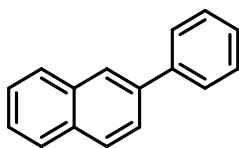

Prepared according to general procedure **C**. Purified by flash column chromatography (Hexane) to give **2-phenyl naphthalene** (74 mg, 72%) as a white solid. **mp**: 101–103 °C. **¹H NMR** (500 MHz, CDCl₃) δ 8.09 – 8.02 (s, 1H), 7.93 – 7.86 (m, 3H), 7.76 – 7.72 (m, 3H), 7.52 – 7.48 (m, 4H) 7.40 – 7.37 (t, *J* = 7.4 Hz, 1H) ppm. **¹³C NMR** (500 MHz, CDCl₃) δ 141.1, 138.5, 133.6, 132.6, 128.9, 128.4, 128.2, 127.6, 127.4, 127.4, 126.3, 125.9, 125.8, 125.6 ppm.

This data is consistent with the literature.^[13]

2-(4-methoxyphenyl) naphthalene (3c)

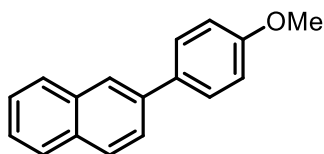

Prepared according to general procedure **C** however using 78 °C as the mid temperature and 130 °C as the final temperature. Purified by flash column chromatography (Hexane: Ethyl Acetate, 100:0 - 97:3 v:v) to give **2-(4-methoxyphenyl) naphthalene** (76 mg, 70%) as a white solid. **mp**: 132–136 °C. **¹H NMR** (400 MHz, CDCl₃) δ 8.02 – 7.97 (s, 1H), 7.95 – 7.81 (m, 3H), 7.76 – 7.70 (dd, *J* = 8.6, 1.9 Hz, 1H), 7.69 – 7.63 (m, 2H), 7.53 – 7.43 (m, 2H), 3.91 – 3.86 (s, 3H) ppm. **¹³C NMR** (101 MHz, CDCl₃) δ 159.4, 138.3, 133.9, 133.8, 128.6, 128.5, 128.2, 127.8, 126.4, 125.8, 125.6, 125.2, 114.5, 55.5 ppm.

This data is consistent with the literature.^[2]

2-(4-isopropoxyphenyl)naphthalene (3f)

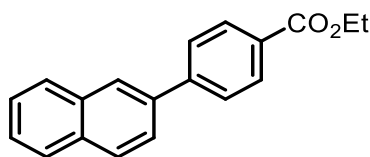

Prepared according to general procedure **C** however using 78 °C as the mid temperature and 130 °C as the final temperature. Purified by flash column chromatography (Hexane: Ethyl Acetate, 100:0 - 90:10 v:v) to give **2-(4-isopropoxyphenyl) naphthalene** (47 mg, 36%) as a white solid. **mp**: 105–109 °C. **¹H NMR** (400 MHz, CDCl₃) δ 8.01 – 7.98 (s, 1H), 7.92 – 7.82 (m, 3H), 7.76 – 7.70 (dd, *J* = 8.5, 1.9 Hz, 1H), 7.68 – 7.62 (m, 2H), 7.53 – 7.43 (m, 2H), 7.04 – 6.98 (m, 2H), 4.71 – 4.56 (hept, *J* = 6.1 Hz, 1H), 1.44 – 1.35 (d, *J* = 6.1 Hz, 6H) ppm. **¹³C NMR** (101 MHz, CDCl₃) 157.6, 138.2, 133.8, 133.4, 132.3, 128.4, 128.3, 128.1, 127.6, 126.2, 125.6, 125.5, 125.0, 116.2, 70.0, 22.1 ppm. **IR**: ν_{max} : 3314, 2978, 2926, 1595, 1498 cm⁻¹. **HRMS** (ESI): *m/z* calculated for C₁₉H₁₈O requires 363.1436 for [M+H]⁺, found 326.1432.

2-(4-Trifluoromethylphenyl) naphthalene (3g)

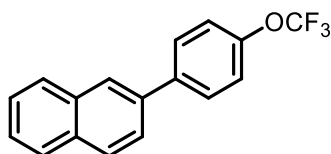

Prepared according to general procedure **C**. Purified by flash column chromatography (Hexane: Ethyl Acetate, 100:0 – 90:10 v:v) to give **2-(4-Trifluoromethylphenyl) naphthalene** (156 mg, 54%) as a white solid. **mp**: 107–110 °C. $^1\text{H NMR}$ (500 MHz, CDCl_3) δ 8.04 – 8.00 (s, 1H), 7.96 – 7.85 (m, 3H), 7.77 – 7.68 (m, 3H), 7.56 – 7.48 (tt, $J = 6.9, 5.2$ Hz, 2H), 7.36 – 7.31 (d, $J = 7.7$ Hz, 2H) ppm. $^{13}\text{C NMR}$ (126 MHz, CDCl_3) 148.8, 140.0, 137.3, 133.7, 132.8, 128.9, 128.8, 128.3, 127.8, 126.7, 126.4, 126.1, 125.4, 121.5, 120.7 (q, $J = 257.0$ Hz) ppm **IR**: ν_{max} : 3060, 1607, 1502, 1267, 1208, 1156, 1111, 1014 cm^{-1} . $^{19}\text{F}\{^1\text{H}\}$ NMR (659 MHz, CDCl_3) δ -57.58.

Analysis by HRMS was not possible due to lack of ionisation despite multiple attempts.

2-(4-methylphenyl) naphthalene (3h)

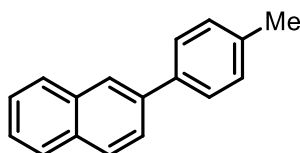

Prepared according to general procedure **C**. Purified by flash column chromatography (Hexane) to give **2-(4-methylphenyl) naphthalene** (55 mg, 50%) as a white solid. **mp**: 94–96 °C. $^1\text{H NMR}$ (400 MHz, CDCl_3) δ 8.05 – 8.01 (s, 1H), 7.94 – 7.84 (m, 3H), 7.77 – 7.72 (dd, $J = 8.5, 1.8$ Hz, 1H), 7.66 – 7.61 (d, $J = 8.1$ Hz, 2H), 7.54 – 7.44 (m, 2H), 7.33 – 7.28 (d, $J = 7.8$ Hz, 2H), 2.46 – 2.41 (s, 3H) ppm. $^{13}\text{C NMR}$ (101 MHz, CDCl_3) δ 138.6, 138.4, 137.3, 133.9, 132.7, 129.7, 128.5, 128.3, 127.8, 127.4, 126.4, 125.9, 125.7, 125.6, 21.3 ppm.

This data is consistent with the literature.^[12]

2-(4-n-Butyl phenyl) naphthalene (3i)

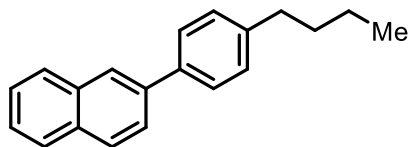

Prepared according to general procedure **C** however using 73 °C as the mid temperature and 120 °C as the final temperature. Purified by flash column chromatography (Hexane) to give **2-(4-n-Butyl phenyl) naphthalene** (67 mg, 52%) as a white solid. **mp**: 45–48 °C. $^1\text{H NMR}$ (400 MHz, CDCl_3) δ 8.06 – 8.01 (s, 1H), 7.96 – 7.83 (m, 3H), 7.79 – 7.72 (dd, $J = 8.5, 1.8$ Hz, 1H), 7.68 – 7.62 (m, 2H), 7.54 – 7.43 (m, 2H), 7.34 – 7.27 (m, 2H), 2.75 – 2.63 (m, 2H), 1.73 – 1.59 (m, 2H), 1.49 – 1.35 (h, $J = 7.4$ Hz, 2H), 1.04 – 0.92 (t, $J = 7.3$ Hz, 3H) ppm. $^{13}\text{C NMR}$ (101 MHz, CDCl_3) δ 142.4, 138.7, 138.6, 133.9, 132.7, 129.1, 128.5, 128.3, 127.8, 127.4, 126.4, 125.9, 125.7, 125.6, 35.5, 33.8, 22.6, 14.1 ppm.

This data is consistent with the literature.^[12]

2-(4-tert-butylphenyl) naphthalene (3j)

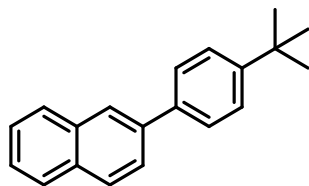

Prepared according to general procedure **C** however using 73 °C as the mid temperature and 120 °C as the final temperature. Purified by flash column chromatography (Hexane) to give **2-(4-tert-butylphenyl) naphthalene** (88 mg, 68%) as a white solid. **mp**: 110–114 °C. **¹H NMR** (400 MHz, CDCl₃) δ 8.07 – 8.01 (s, 1H), 7.94 – 7.82 (m, 3H), 7.79 – 7.72 (dd, *J* = 8.5, 1.9 Hz, 1H), 7.72 – 7.65 (m, 2H), 7.57 – 7.43 (m, 4H), 1.42 – 1.38 (s, 9H) ppm. **¹³C NMR** (101 MHz, CDCl₃) δ 150.6, 138.6, 138.4, 133.9, 132.7, 128.5, 128.3, 127.8, 127.2, 126.4, 126.0, 125.9, 125.7, 125.7, 34.7, 31.5 ppm.

This data is consistent with the literature.^[14]

2-(4-Acetylphenyl) naphthalene (3k)

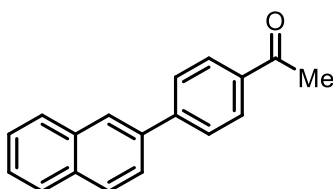

Prepared according to general procedure **C**. Purified by flash column chromatography (Hexane: Ethyl Acetate, 100:0 - 93:7 v:v) to give **2-(4-Acetylphenyl) naphthalene** (95 mg, 77%) as a white solid. **mp**: 115–121 °C. **¹H NMR** (400 MHz, CDCl₃) δ 8.10 – 8.08 (m, 3H), 7.96 – 7.88 (m, 3H), 7.84 – 7.82 (d, *J* = 8.5 Hz, 2H), 7.78 – 7.76 (dd, *J* = 1.9, 8.5 Hz, 1H), 7.74 – 7.52 (m, 2H), 2.71 – 2.61 (s, 3H). **¹³C NMR** (101 MHz, CDCl₃) δ 197.8, 145.7, 137.1, 135.8, 133.5, 133.0, 129.0, 128.7, 128.4, 127.7, 127.5, 126.6, 126.5, 126.4, 125.2, 26.7 ppm.

This data is consistent with the literature. ^[15]

2-(4-ethoxycarbonylphenyl) naphthalene (3l)

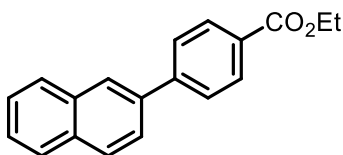

Prepared according to general procedure **C**. Purified by flash column chromatography (Hexane: Ethyl Acetate, 100:0 - 95:5 v:v) to give **2-(4-ethoxycarbonylphenyl) naphthalene** (80 mg, 58%) as a white solid. **mp**: 87–91 °C. **¹H NMR** (400 MHz, CDCl₃) δ 8.16 – 8.14 (d, *J* = 8.5 Hz, 2H), 8.10 – 8.04 (s, br, 1H), 7.94 – 7.86 (m, 3H), 7.79 – 7.75 (m, 3H), 7.54 – 7.49 (m, 2H), 4.44 – 4.39 (q, *J* = 7.2 Hz, 2H), 1.44 – 1.41 (t, *J* = 7.2 Hz, 3H) ppm. **¹³C NMR** (101 MHz, CDCl₃) δ 166.5, 145.4, 137.3, 133.5, 132.9, 130.1, 129.2, 128.6, 128.3, 127.6, 127.2, 126.5, 126.4, 126.3, 125.2, 61.0, 14.4 ppm.

This data is consistent with the literature. ^[16]

2-(4-trifluorophenyl) naphthalene (3m)

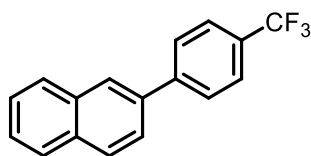

Prepared according to general procedure **C**. Purified by flash column chromatography (Hexane) to give **2-(4-trifluorophenyl) naphthalene** (77 mg, 57%) as a white solid. **mp**: 129–132 °C. **¹H NMR** (400 MHz, CDCl₃) δ 8.09 – 8.03 (s, br, 1H), 7.95 – 7.87 (m, 3H), 7.83 – 7.81 (d, *J* = 8.0 Hz, 2H), 7.74 – 7.72 (m, 3H), 7.55 – 7.50 (m, 2H) ppm. **¹³C NMR** (101 MHz, CDCl₃) δ 144.6, 137.0, 133.5, 132.9, 129.3 (q, *J* = 33.0 Hz), 128.8, 128.3, 127.7, 127.7, 126.6, 126.5, 126.3, 125.8 (q, *J* = 3.7 Hz), 125.2, 123.2 ppm.

This data is consistent with the literature. [17]

2-(4-cyanophenyl) naphthalene (3n)

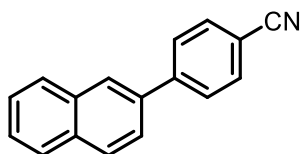

Prepared according to general procedure **C**. Purified by flash column chromatography (Hexane: Ethyl Acetate, 100:0 - 90:10 v:v) to give **2-(4-cyanophenyl) naphthalene** (34 mg, 30%) as a white solid. **mp**: 156–161 °C. **¹H NMR** (400 MHz, CDCl₃) δ 8.02 – 7.97 (s, br, 1H), 7.96 – 7.87 (m, 3H), 7.83 – 7.80 (d, *J* = 8.7 Hz, 2H), 7.77 – 7.75 (d, *J* = 8.6 Hz, 2H), 7.72 – 7.69 (dd, *J* = 1.9, 8.6 Hz, 1H), 7.56 – 7.51 (m, 2H) ppm. **¹³C NMR** (101 MHz, CDCl₃) δ 145.6, 136.4, 133.5, 133.1, 132.6, 128.9, 128.4, 127.9, 127.7, 126.8, 126.7, 126.5, 124.8, 118.9, 110.9 ppm.

This data is consistent with the literature. [18]

3-(dibenzo[b,d]thiophen-2-yl)pyridine (3q)

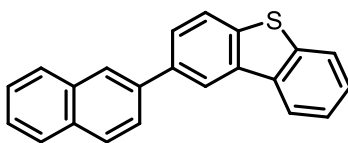

Prepared according to general procedure **C**. Purified by flash column chromatography (Hexane) to give **3-(dibenzo[b,d]thiophen-2-yl)pyridine** (129 mg, 83%) as a white solid. **mp**: 102–106 °C. **¹H NMR** (500 MHz, CDCl₃) δ 8.51 – 8.46 (s, 1H), 8.29 – 8.26 (m, 1H), 8.18 – 8.15 (s, 1H), 7.99 – 7.82 (m, 7H), 7.55 – 7.49 (m, 4H) ppm. **¹³C NMR** (101 MHz, CDCl₃) δ 140.0, 138.7, 138.5, 137.8, 136.2, 135.6, 133.8, 132.7, 128.6, 128.2, 127.7, 126.9, 126.4, 126.0, 125.8, 124.5, 123.1, 123.0, 121.7, 120.3 ppm. **IR**: ν_{max} : 3306, 1725, 1625, 1524, 1453, 1375, 1341 cm⁻¹.

Analysis by HRMS was not possible due to lack of ionisation despite multiple attempts.

1-(4-Fluorophenyl)naphthalene (3d)

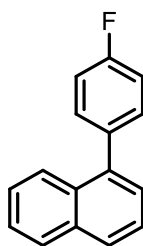

Prepared according to general procedure **C**. Purified by flash column chromatography (Hexane) to give **1-(4-Fluorophenyl)naphthalene** (89 mg, 80%) as a white solid. **mp**: 68–71 °C. **¹H NMR** (400 MHz, CDCl₃) δ 7.95 – 7.89 (d, *J* = 8.1 Hz, 1H), 7.89 – 7.82 (t, *J* = 8.9 Hz, 2H), 7.59 – 7.38 (m, 6H), 7.24 – 7.15 (t, *J* = 8.7 Hz, 2H) ppm. **¹³C NMR** (101 MHz, CDCl₃) δ 162.3 (d, *J* = 246.41 Hz), 139.1, 136.6 (d, *J* = 3.0 Hz), 133.8, 131.6, 131.5, 128.3, 127.8, 127.0, 126.2, 125.9, 125.8, 125.4, 115.2 (d, *J* = 21.1 Hz) ppm

This data is consistent with the literature.^[9]

4-Fluoro-1,1':4',1''-terphenyl (3e)

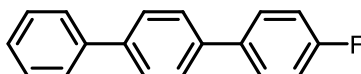

Prepared according to general procedure **C**. Purified by flash column chromatography (Hexane) to give **4-Fluoro-1,1':4',1''-terphenyl** (72 mg, 58%) as a white solid. **mp**: 215–218 °C. **¹H NMR** (400 MHz, CDCl₃) δ 7.69 – 7.59 (m, 8H), 7.49 – 7.46 (t, *J* = 7.7 Hz, 2H), 7.39 – 7.36 (t, *J* = 7.4 Hz, 3H), 7.17 – 7.14 (t, *J* = 8.6 Hz, 2H) ppm. **¹³C NMR** (101 MHz, CDCl₃) δ 162.5 (d, *J* = 246.5 Hz), 140.6, 140.1, 139.1, 136.8 (d, *J* = 3.5 Hz), 128.8, 128.5 (d, *J* = 8.2 Hz), 127.6, 127.4, 127.4, 127.0, 115.7 (d, *J* = 21.2 Hz) ppm

This data is consistent with the literature. ^[9]

1-(4-fluorophenyl)-4-methoxynaphthalene (3r)

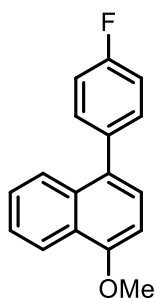

Prepared according to general procedure **C**. Purified by flash column chromatography (Hexane: DCM, 100:0 – 95:5 v:v) to give **1-(4-fluorophenyl)-4-methoxynaphthalene** (72 mg, 57%) as a white solid. **mp**: 94–97 °C. **¹H NMR** (400 MHz, CDCl₃) δ 8.37 – 8.35 (d, *J* = 8.0 Hz, 1H), 7.82 – 7.80 (d, *J* = 8.7 Hz, 1H), 7.53 – 7.42 (m, 4H), 7.32 – 7.31 (d, *J* = 7.8 Hz, 1H), 7.19 – 7.16 (t, *J* = 8.6 Hz, 2H), 6.88 – 6.87 (d, *J* = 7.9 Hz, 1H), 4.08 – 4.02 (s, 3H) ppm. **¹³C NMR** (101 MHz, CDCl₃) δ 162.0 (d, *J* = 245.6 Hz), 155.0, 136.8 (d, *J* = 2.9 Hz), 132.5, 131.7 (2C), 131.5, 126.8 (d, *J* = 38.7 Hz), 125.6, 125.5, 125.2, 122.2, 115.1 (d, *J* = 21.1 Hz), 103.3, 55.6 ppm. **¹⁹F{¹H} NMR** (659 MHz, CDCl₃) δ –116.09 (s). **IR**: ν_{max} : 3064, 3042, 3008, 2967, 2840, 2076, 1587.8, 1510, 1461, 1387 cm⁻¹.

Analysis by HRMS was not possible due to lack of ionisation despite multiple attempts.

4-fluoro-4'-methoxy-1,1'-biphenyl (3s)

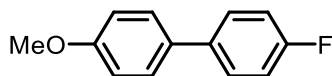

Prepared according to general procedure **C**. Purified by flash column chromatography (Hexane: Ethyl Acetate, 100:0 - 95:5 v:v) to give **4-fluoro-4'-methoxy-1,1'-biphenyl** (38 mg, 37%) as a white solid. **mp**: 87–88 °C. **¹H NMR** (400 MHz, CDCl₃) δ 7.52 – 7.46 (m, 4H), 7.13 – 7.08 (t, *J* = 8.7 Hz, 2H), 6.97 – 6.94 (d, *J* = 9.0 Hz, 2H), 3.89 – 3.82 (s, 3H) ppm. **¹³C NMR** (101 MHz, CDCl₃) δ 162.1 (d, *J* = 245.6 Hz), 159.1, 137.0 (d, *J* = 2.8 Hz), 132.8, 128.2 (d, *J* = 7.5 Hz), 128.0, 115.5 (d, *J* = 21.1 Hz), 114.2, 55.4 ppm

This data is consistent with the literature.^[20]

4'-fluoro-[1,1'-biphenyl]-4-carbonitrile (3t)

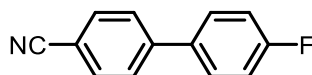

Prepared according to general procedure **C**. Purified by flash column chromatography (Hexane: Ethyl Acetate, 100:0 - 90:10 v:v) to give **4'-fluoro-[1,1'-biphenyl]-4-carbonitrile** (64 mg, 64%) as a white solid. **mp**: 115–118 °C. **¹H NMR** (400 MHz, CDCl₃) δ 7.72 – 7.70 (d, *J* = 8.4 Hz, 2H), 7.64 – 7.62 (d, *J* = 8.4 Hz, 2H), 7.57 – 7.53 (m, 2H), 7.18 – 7.14 (t, *J* = 8.6 Hz, 2H) ppm. **¹³C NMR** (MHz, CDCl₃) δ 163.2 (d, *J* = 249.2 Hz), 144.6, 135.3 (d, *J* = 2.9 Hz), 132.7, 129.0 (d, *J* = 8.3 Hz), 127.6, 118.9, 116.1 (d, *J* = 21.9 Hz), 111.0 ppm

This data is consistent with the literature.^[21]

Methyl 4'-fluoro-[1,1'-biphenyl]-4-carboxylate (3u)

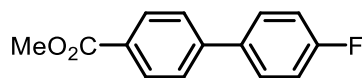

Prepared according to general procedure **C**. Purified by flash column chromatography (Hexane: Ethyl Acetate, 100:0 - 95:5 v:v) to give **methyl 4'-fluoro-[1,1'-biphenyl]-4-carboxylate** (62 mg, 54%) as a white solid. **mp**: 98–100 °C. **¹H NMR** (400 MHz, CDCl₃) δ 8.12 – 8.09 (d, *J* = 8.1 Hz, 2H), 7.62 – 7.57 (m, 4H), 7.17 – 7.14 (t, *J* = 8.7 Hz, 2H), 3.96 – 3.92 (s, 3H) ppm. **¹³C NMR** (101 MHz, CDCl₃) δ 167.1, 163.1 (d, *J* = 248.2 Hz), 144.7, 136.3 (d, *J* = 3.5 Hz), 130.3, 129.1 (d, *J* = 8.2 Hz), 127.0, 115.9 (d, *J* = 21.2 Hz), 52.3 ppm

This data is consistent with the literature.^[22]

2-(4-Fluorophenyl)-pyridine (3v)

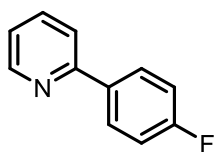

Prepared according to general procedure **C**. Purified by flash column chromatography (Hexane: Ethyl acetate 3:2) to give **2-(4-Fluorophenyl)-pyridine** (5 mg, 5%) as a yellow oil. $^1\text{H NMR}$ (400 MHz, CDCl_3) δ 8.68 – 8.67 (d, $J = 4.7$ Hz, 1H), 8.00 – 7.95 (m, 2H), 7.77 – 7.73 (t, $J = 7.7$ Hz, 1H), 7.69 – 7.67 (d, $J = 8.0$ Hz, 1H), 7.24 – 7.22 (t, $J = 6.2$ Hz, 1H), 7.18 – 7.13 (t, $J = 8.7$ Hz, 2H) ppm. $^{13}\text{C NMR}$ (101 MHz, CDCl_3) δ 164.5, 162.5, 156.6, 149.7, 136.8, 135.5 (d, $J = 3.6$ Hz), 128.7 (d, $J = 6.6$ Hz), 122.0, 120.2, 115.7 (d, $J = 21.5$ Hz) ppm

This data is consistent with the literature.^[23]

3-(4-Fluorophenyl)-pyridine (3w)

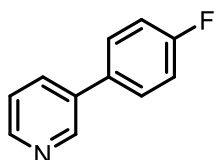

Prepared according to general procedure **C**. Purified by flash column chromatography (Hexane: Ethyl Acetate, 100:0 – 99:1 v:v) to give **3-(4-Fluorophenyl)-pyridine** (45 mg, 52%) as a yellow oil. $^1\text{H NMR}$ (400 MHz, CDCl_3) δ 8.82 – 8.81 (d, $J = 2.4$ Hz, 1H), 8.60 – 8.59 (dd, $J = 1.6, 4.9$ Hz, 1H), 7.85 – 7.82 (ddd, $J = 1.6, 2.4, 7.9$ Hz, 1H), 7.57 – 7.53 (m, 2H), 7.38 – 7.36 (ddd, $J = 0.9, 4.8, 7.9$ Hz, 1H), 7.20 – 7.16 (t, $J = 8.6$ Hz, 2H) ppm. $^{13}\text{C NMR}$ (101 MHz, CDCl_3) δ 162.9 (d, $J = 248.1$ Hz), 148.5, 148.1, 135.7, 134.3, 133.9 (d, $J = 2.8$ Hz), 128.8 (d, $J = 8.1$ Hz), 123.6, 116.1 (d, $J = 21.4$ Hz) ppm

This data is consistent with the literature.^[24]

4,4'-Difluoro-1,1'-biphenyl (4a)

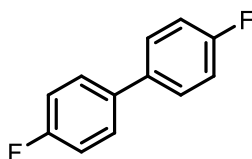

$^1\text{H NMR}$ (400 MHz, CDCl_3) δ 7.57 – 7.44 (m, 4H), 7.18 – 7.07 (m, 4H) ppm.

This data is consistent with the literature.^[25]

12. NMR spectra

2-Naphthyl pivalate (1aa)

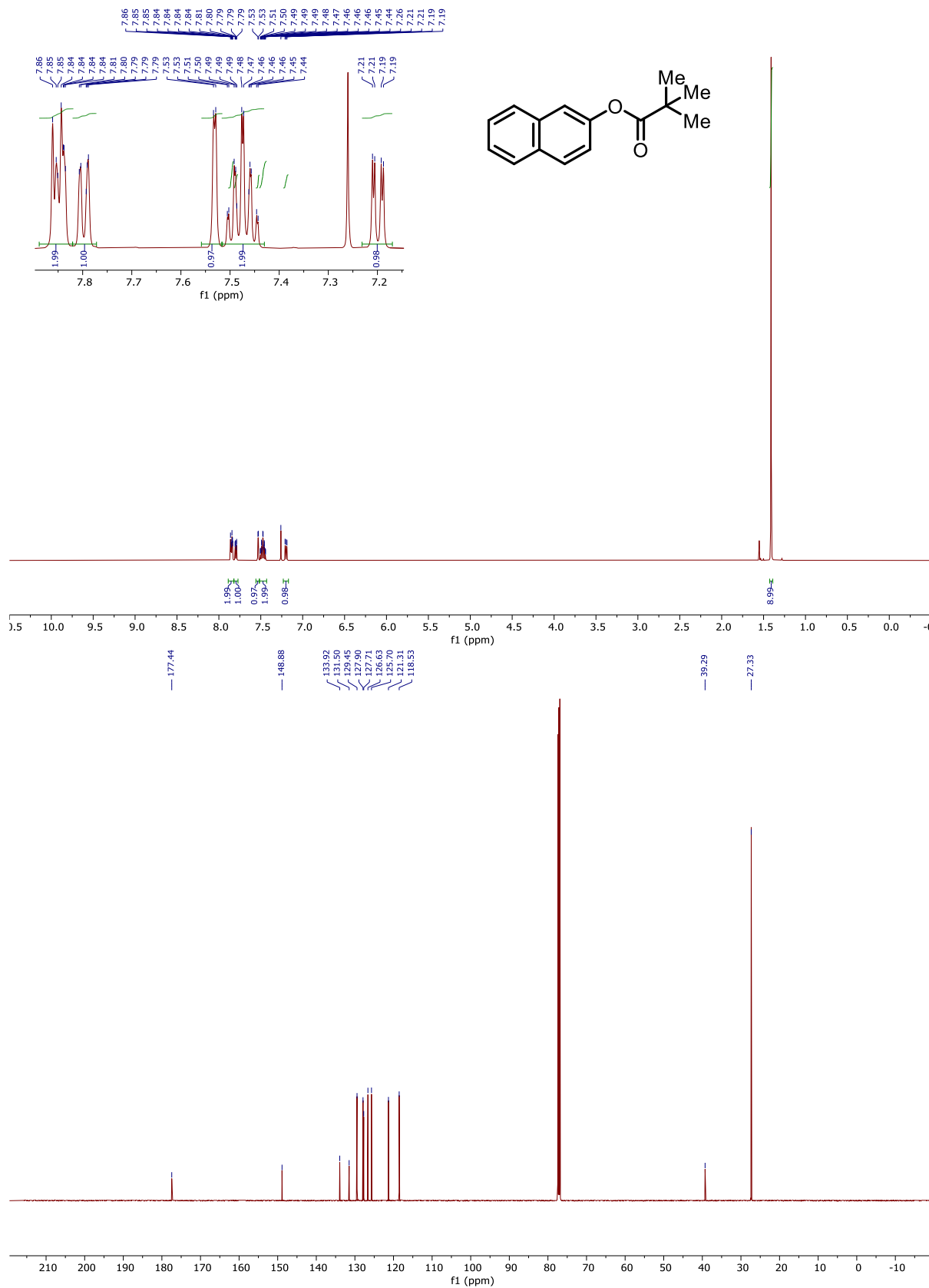

tert-Butyl 2-naphthyl carbonate (1ab)

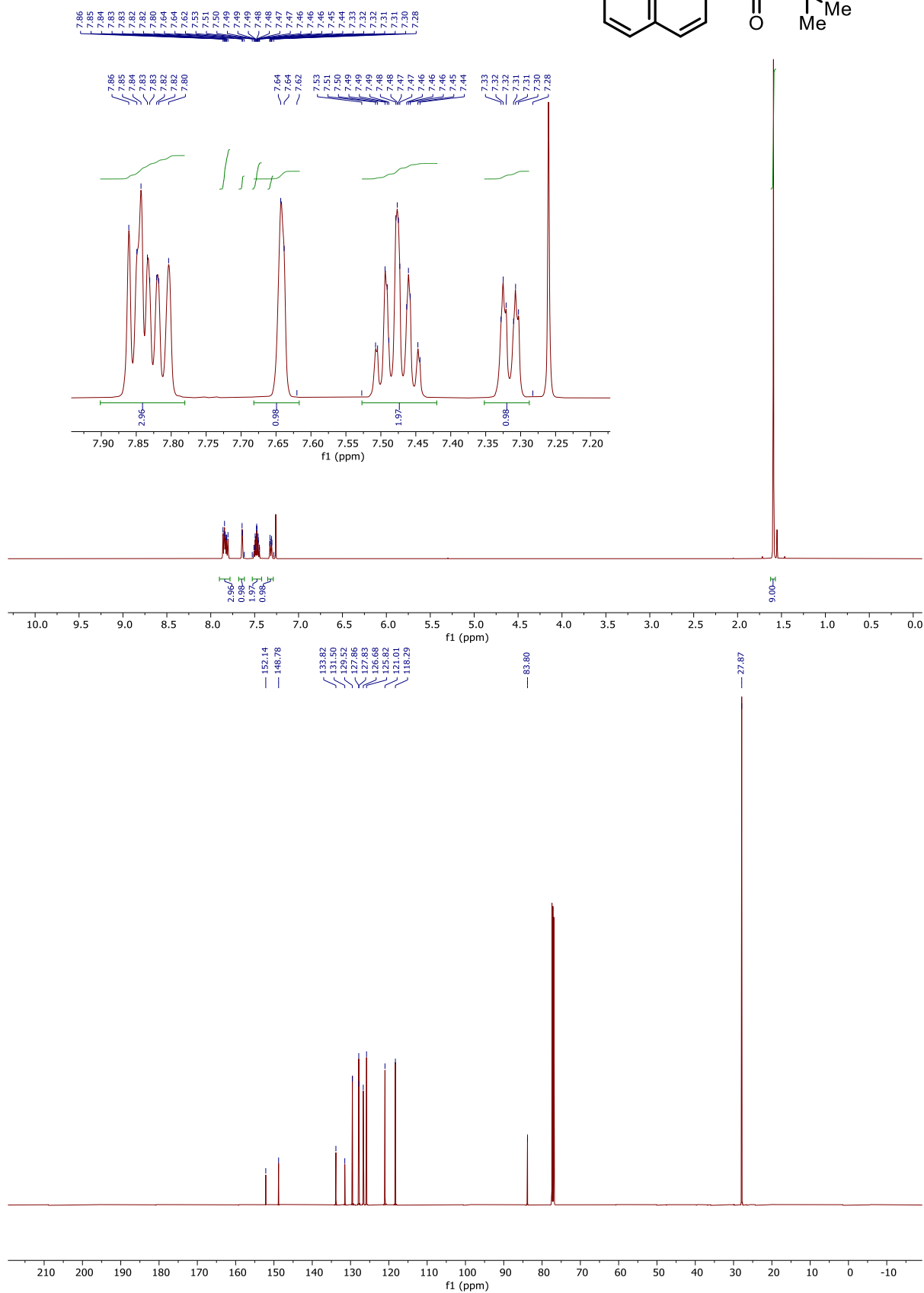
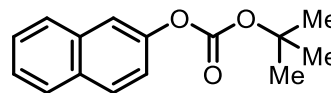

2-Naphthyl diethylcarbamate (1ac)

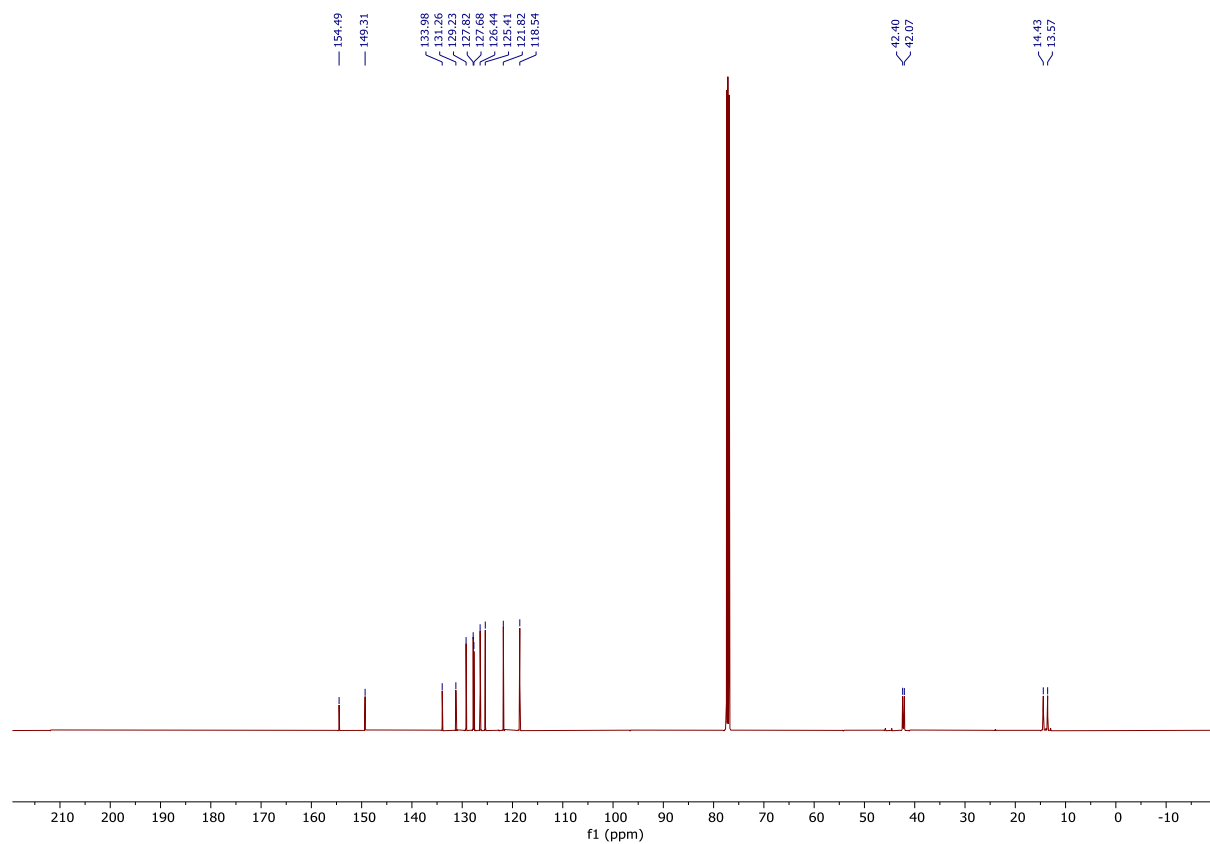
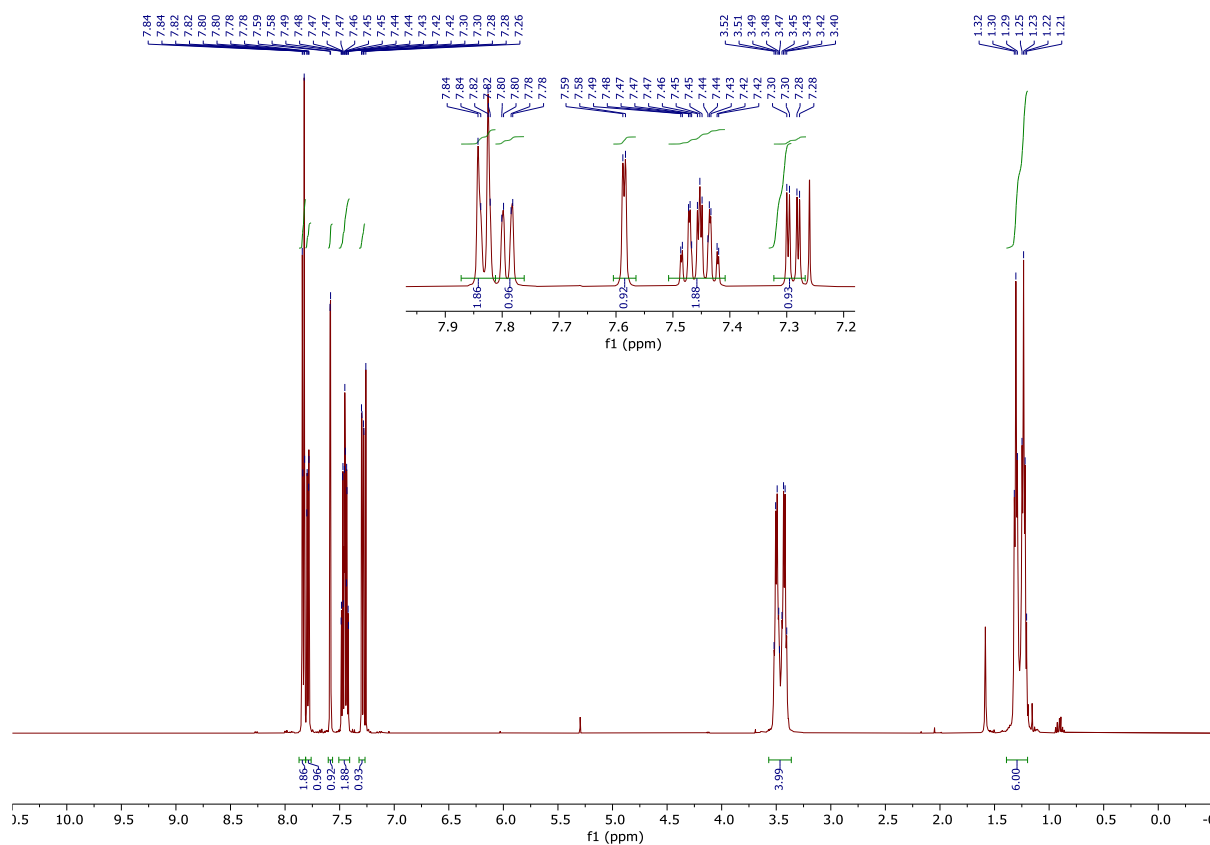
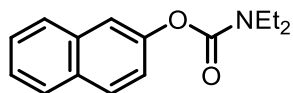

2-Naphthyl triflate (1ad)

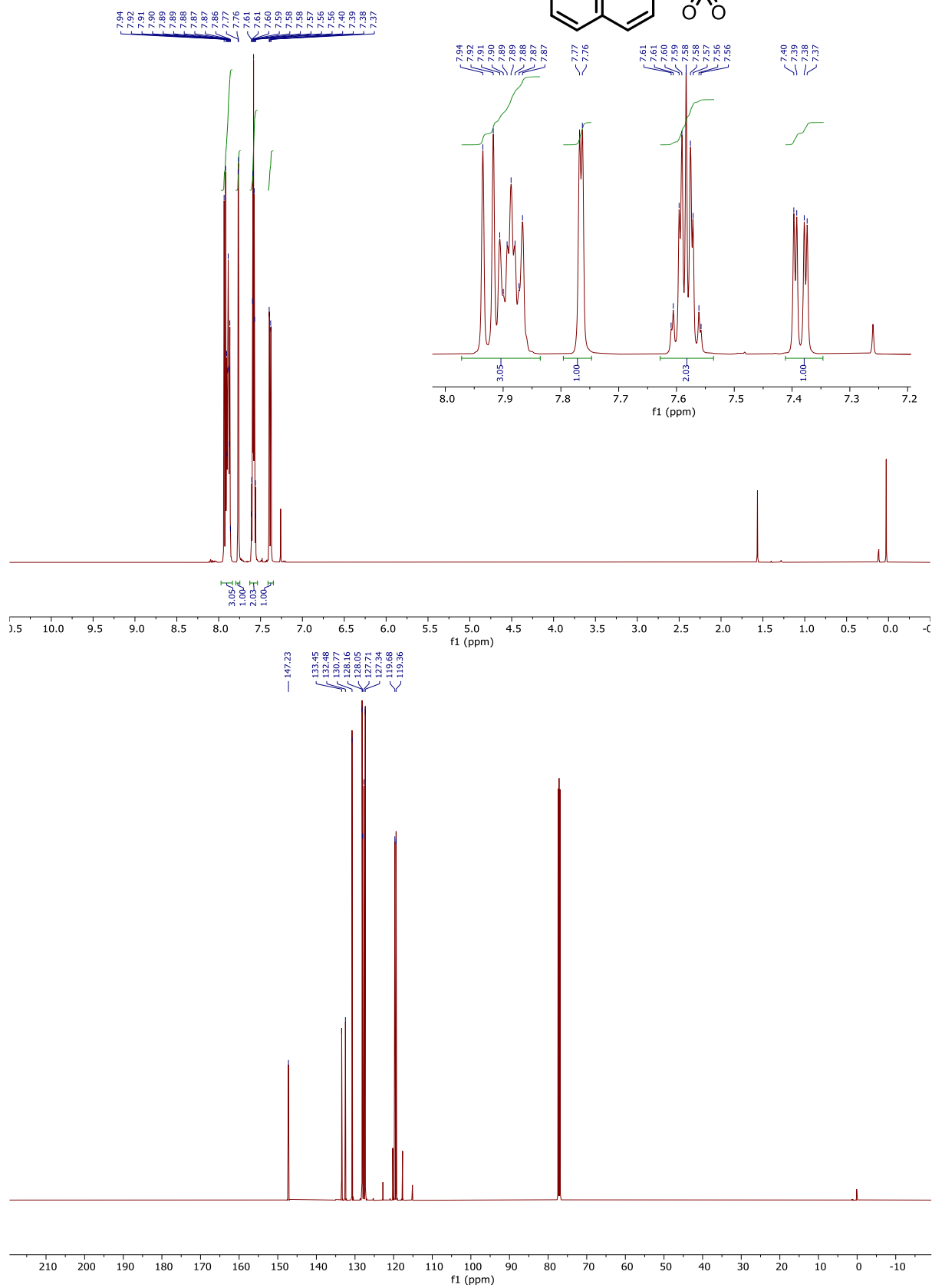
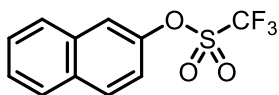

2-Naphthyl tosylate (1ac)

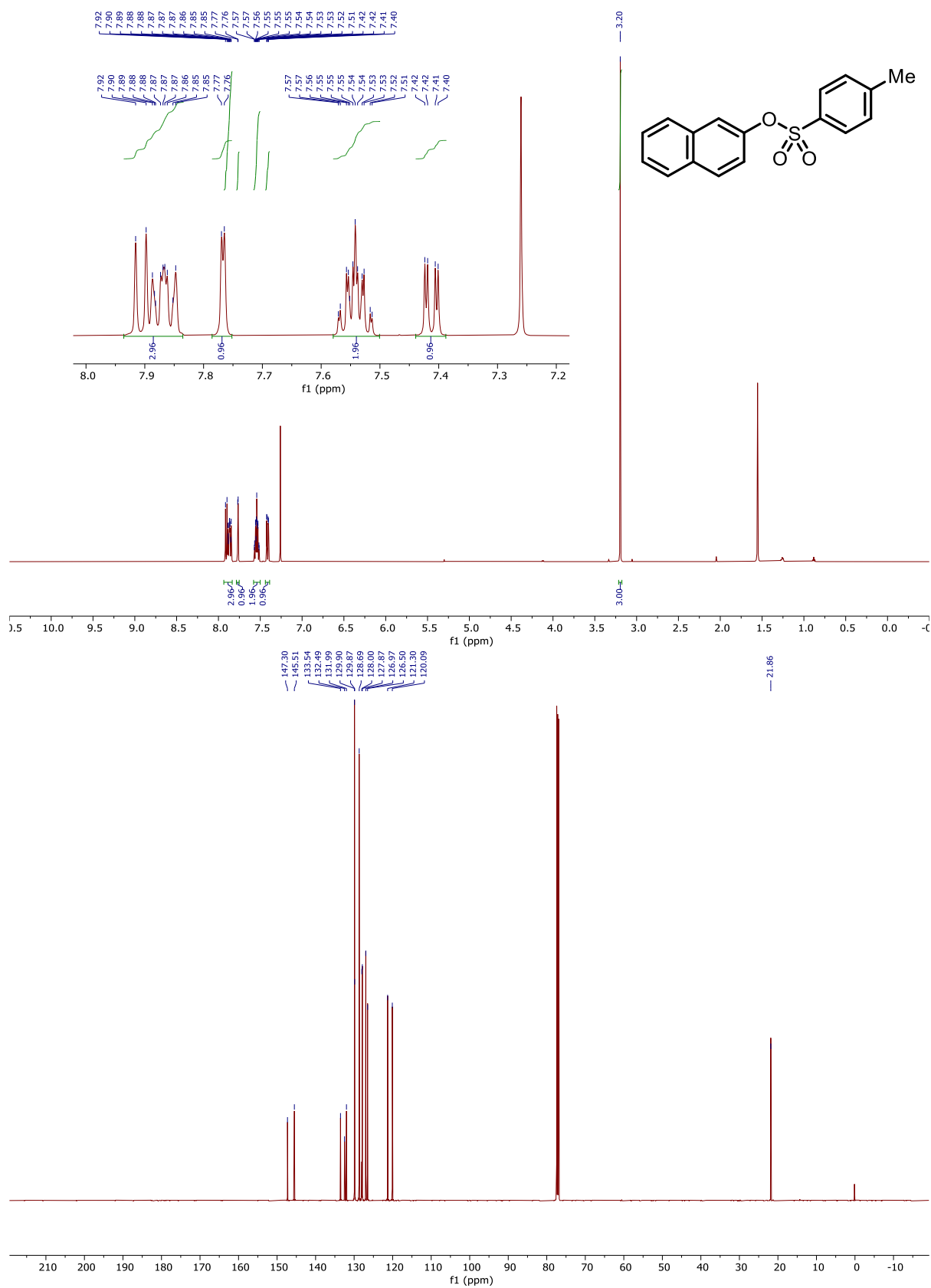

2-Naphthyl mesylate (1af)

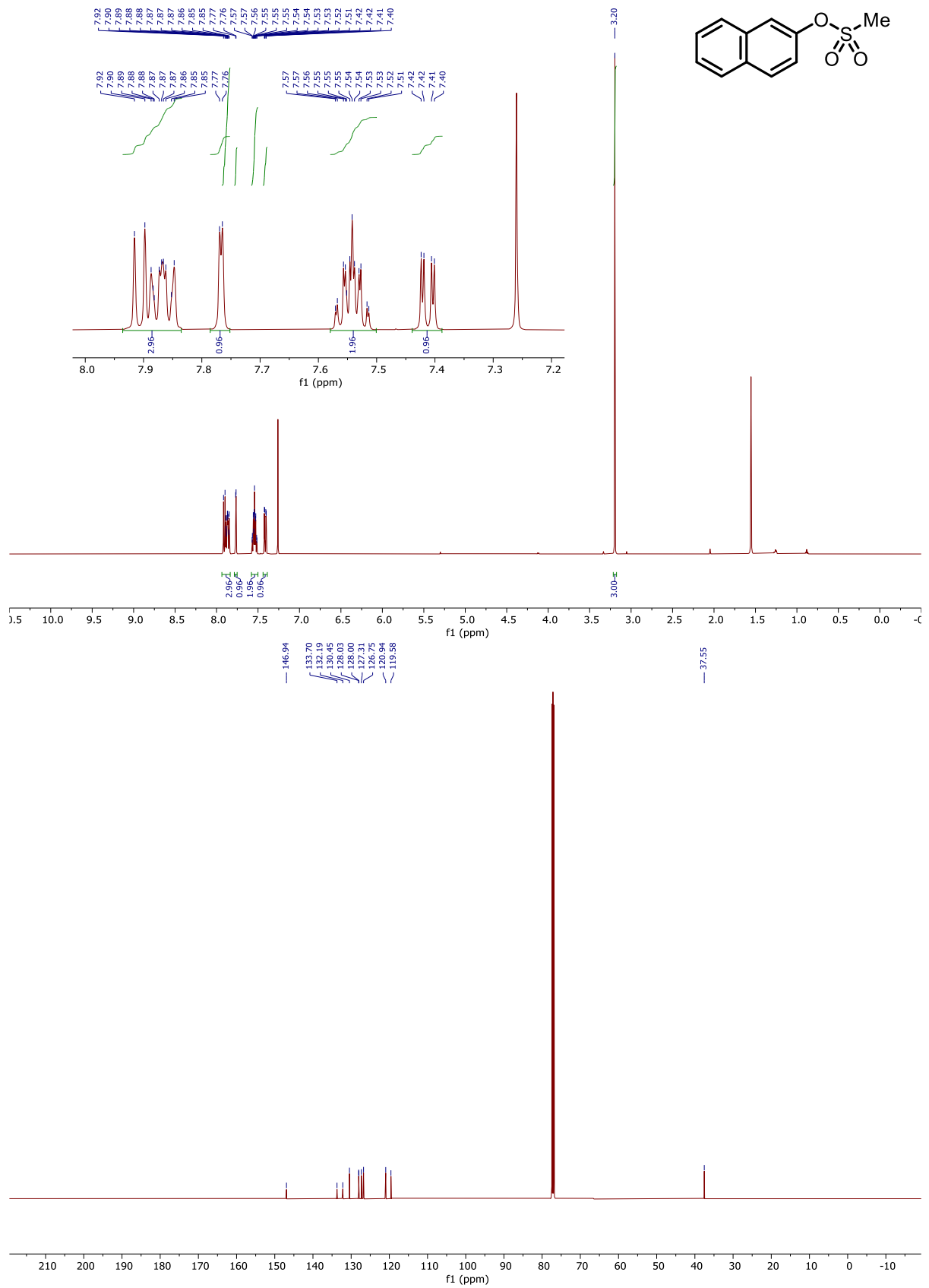

2-Naphthyl dimethylsulfamate (1ag)

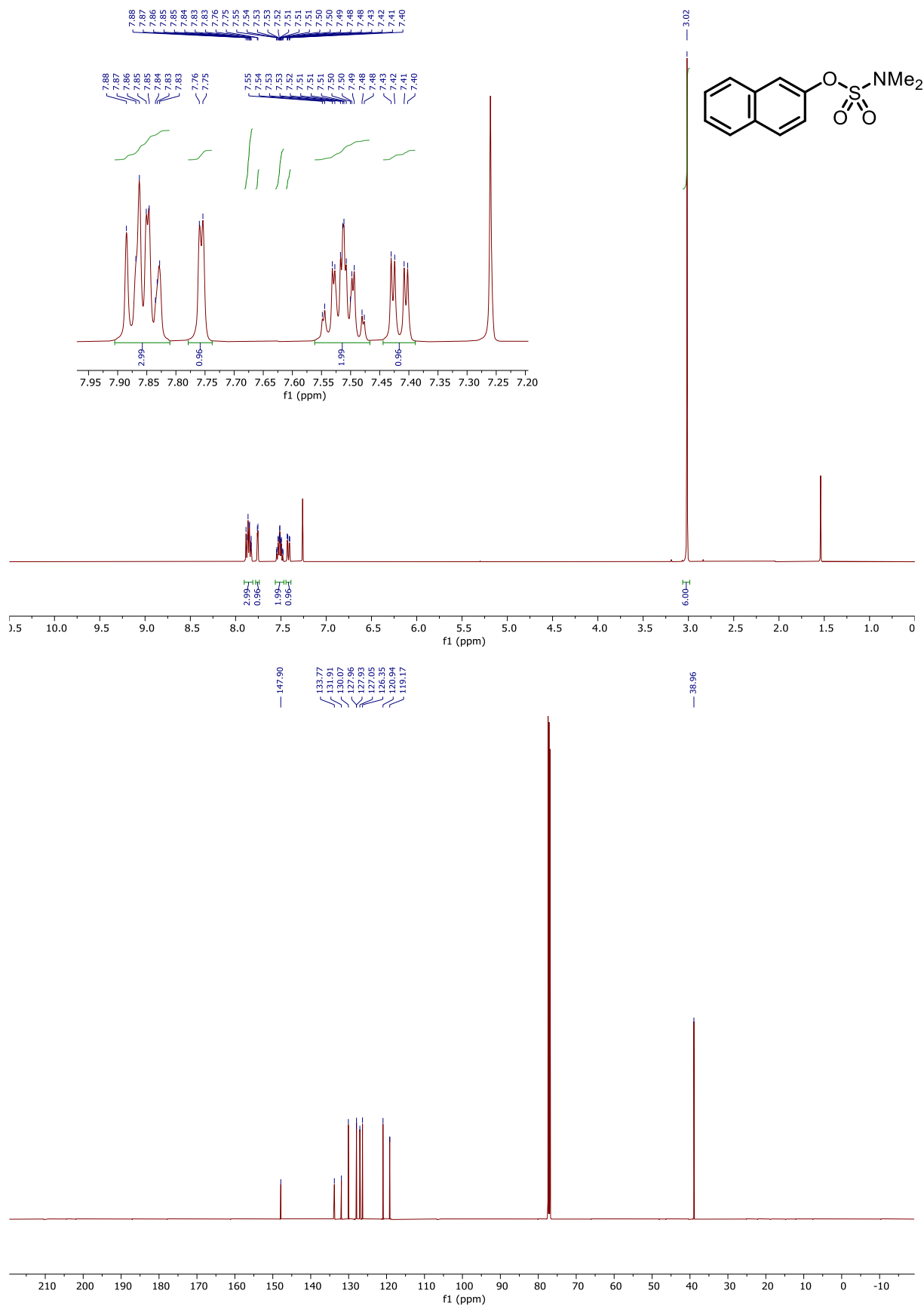

1-Naphthyl dimethylsulfamate (1b)

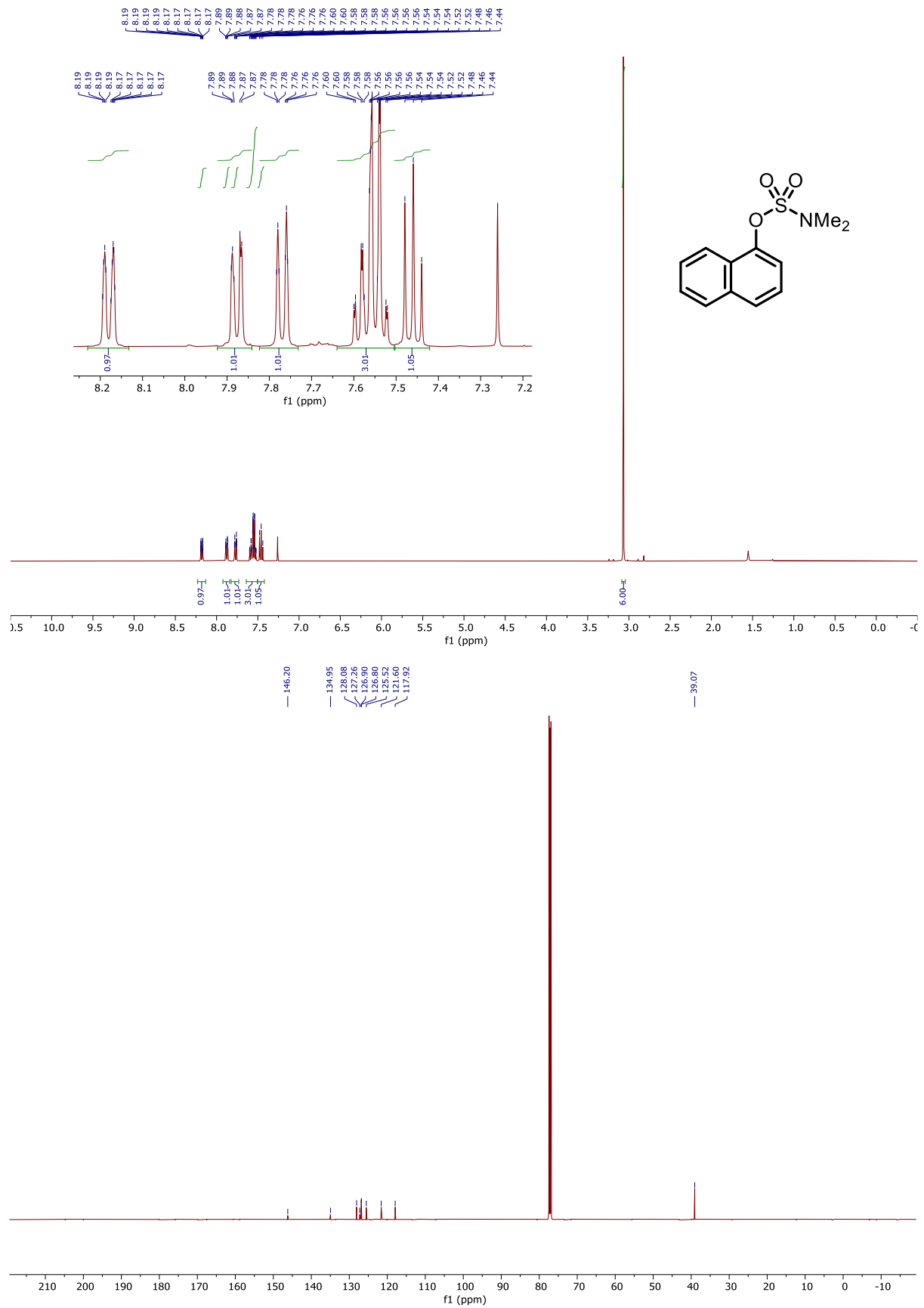

4-Phenylphenyl dimethylsulfamate (1c)

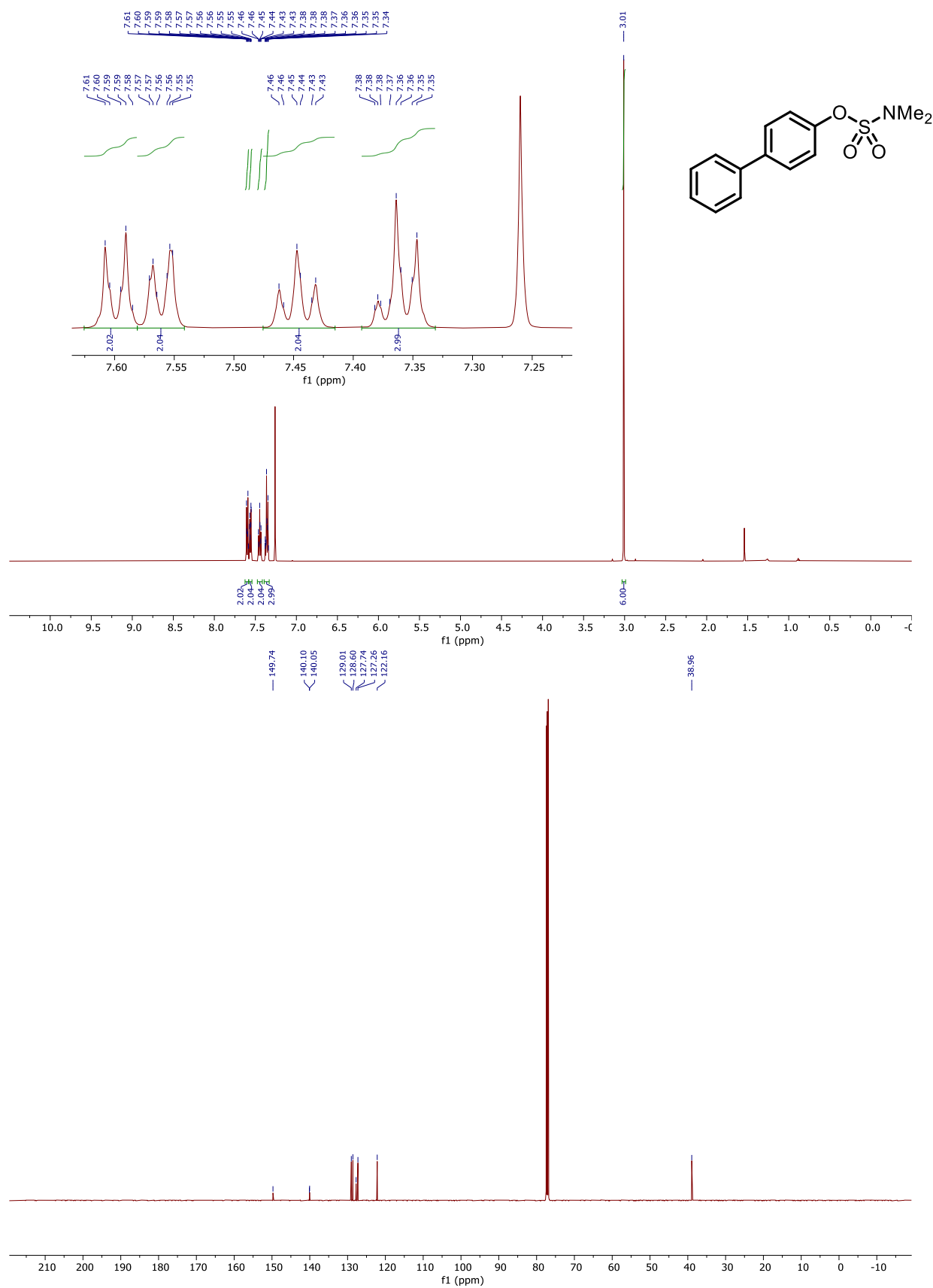

4-Methoxy-1-naphthyl dimethylsulfamate (1d)

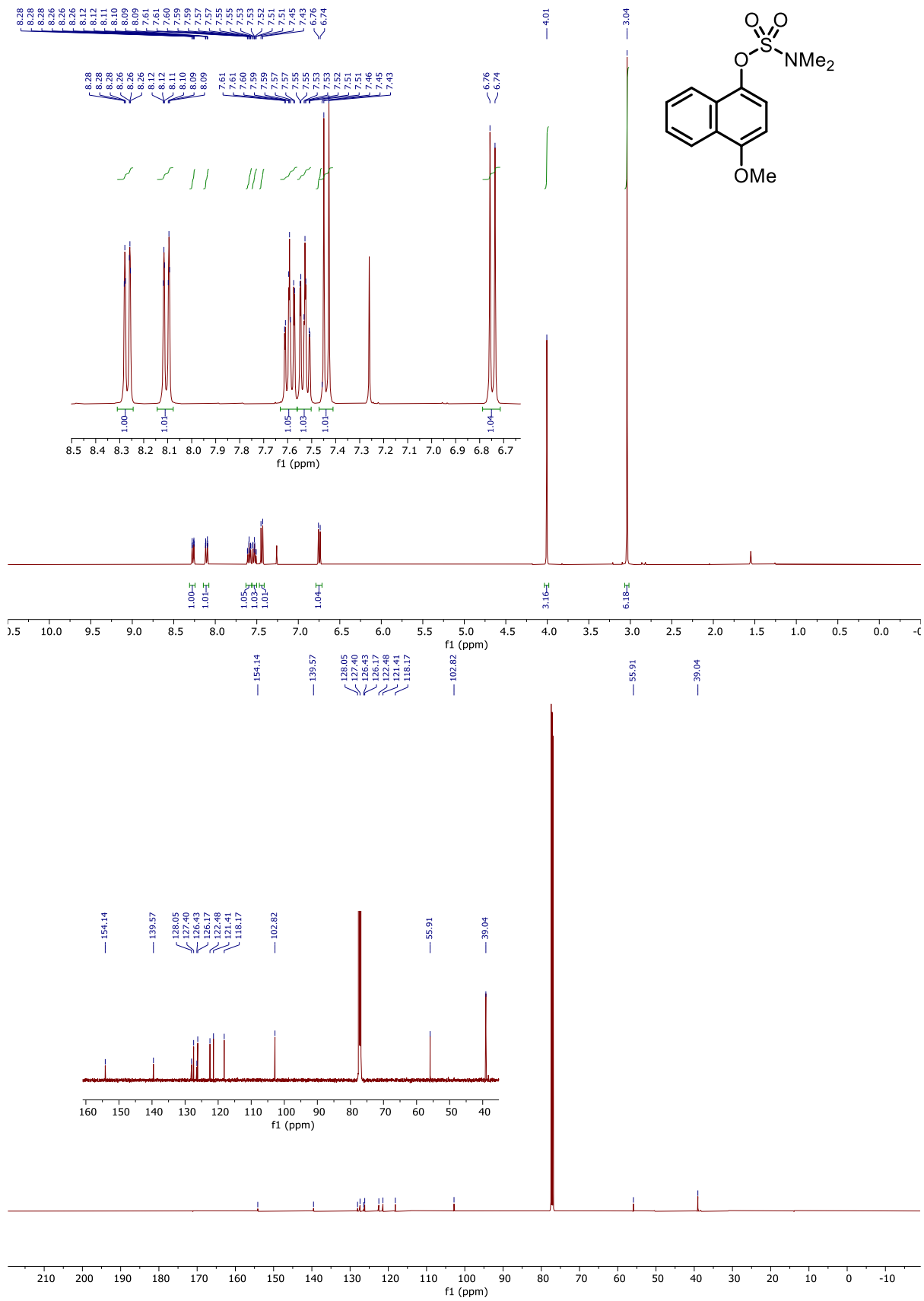

4-Methoxyphenyl dimethylsulfamate (1e)

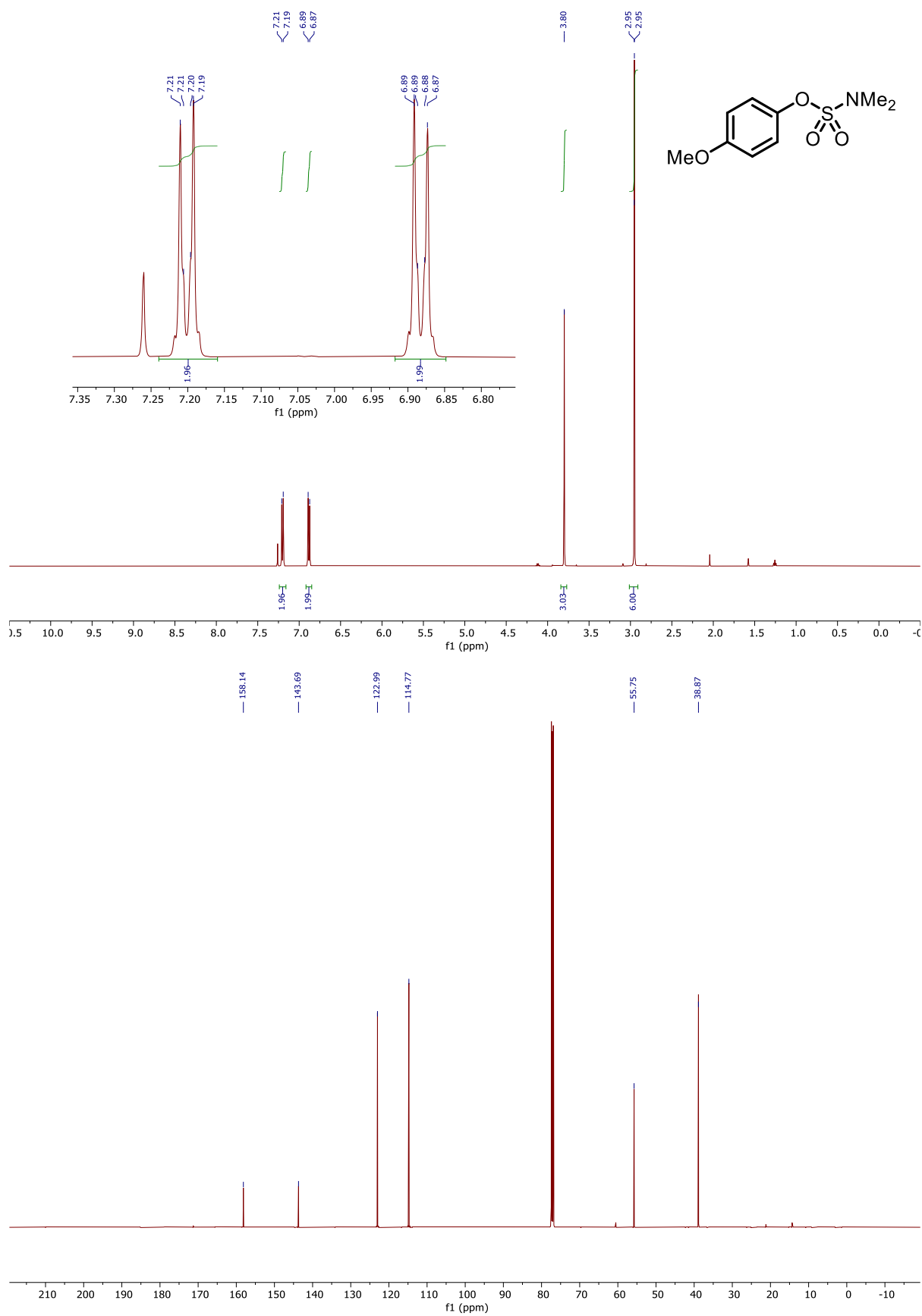

4-Cyanophenyl dimethylsulfamate (1f)

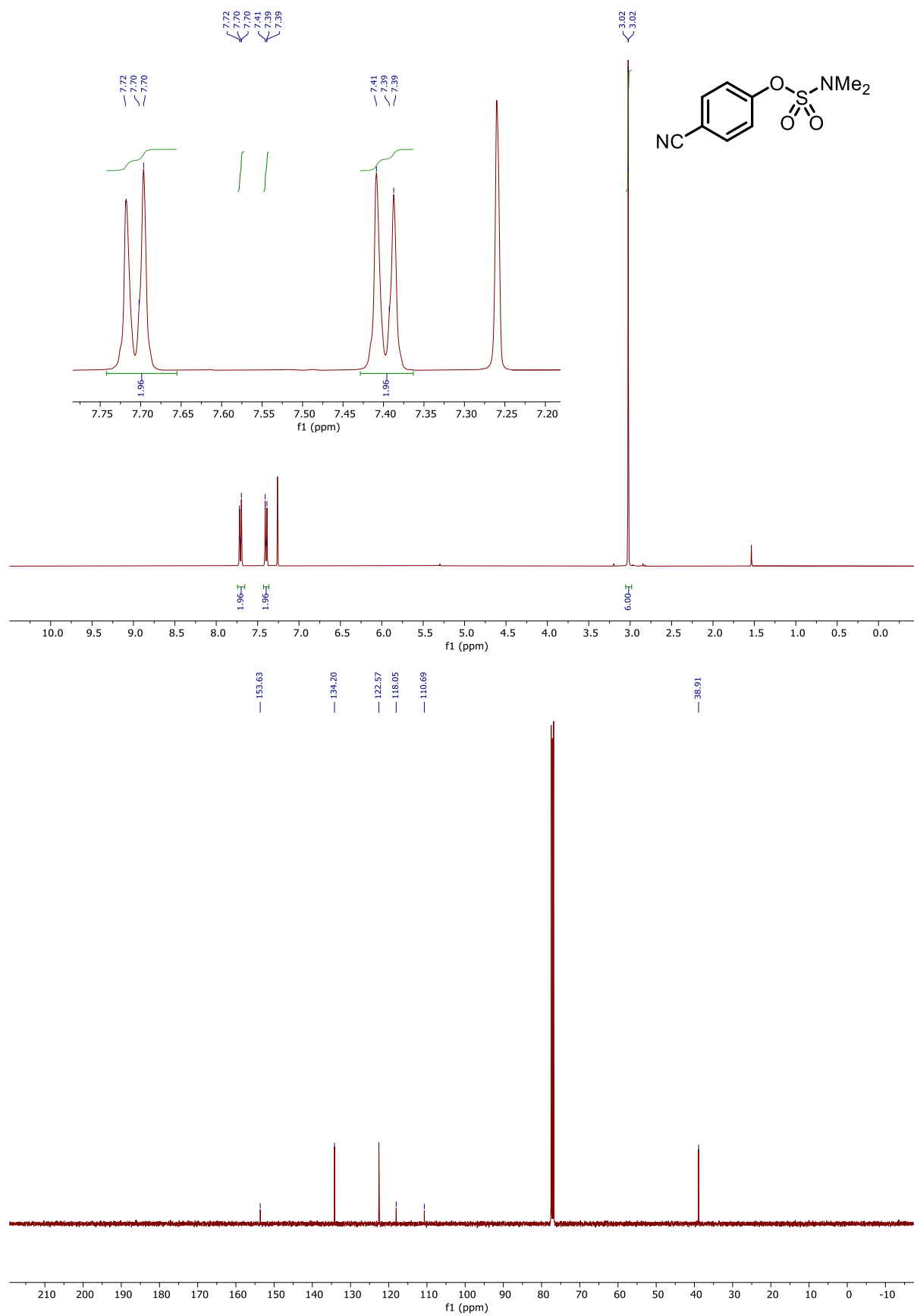

Methyl-4-hydroxybenzyl dimethylsulfamate (1g)

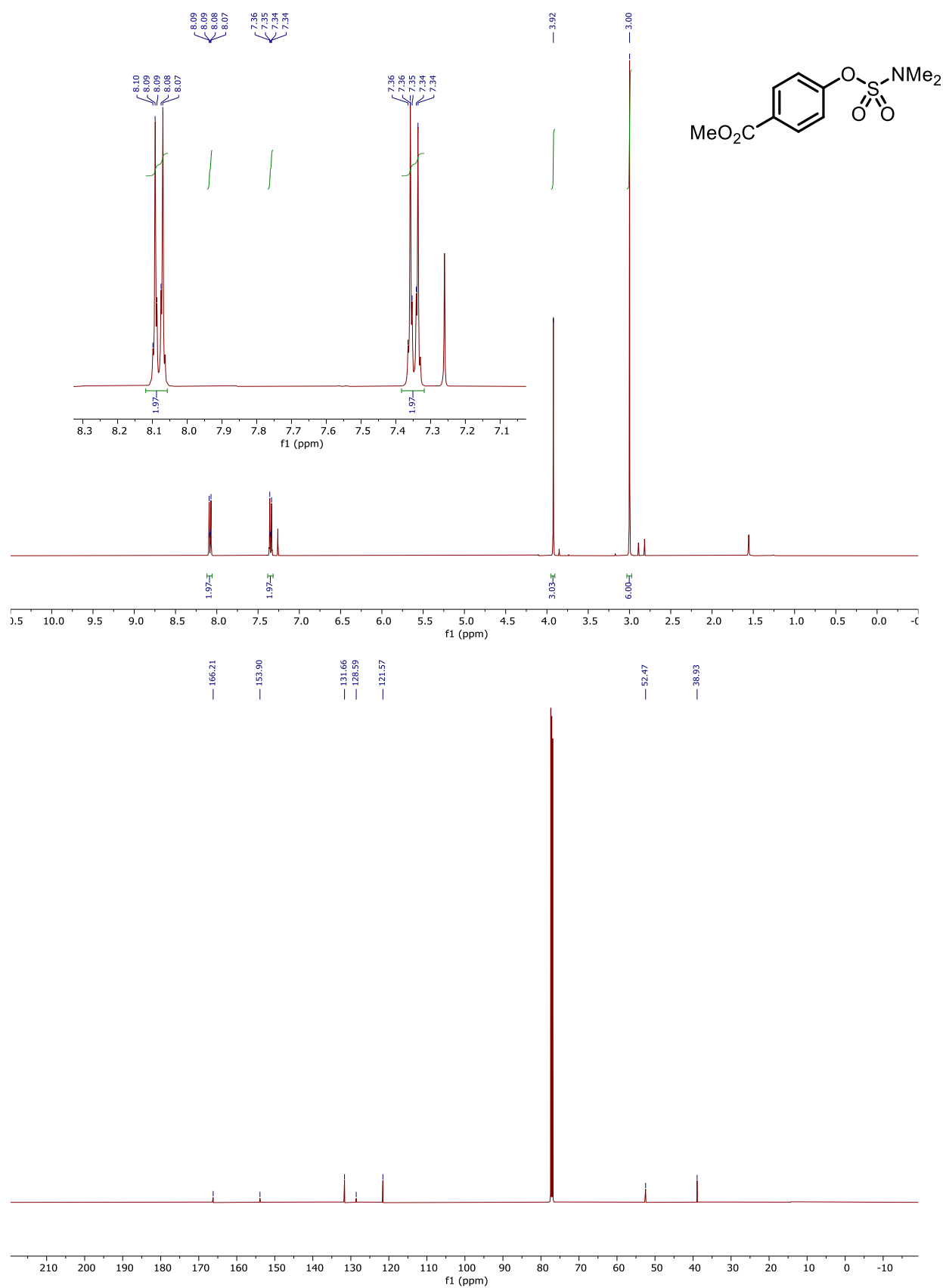

3-hydroxypyridyl dimethylsulfamate (1h)

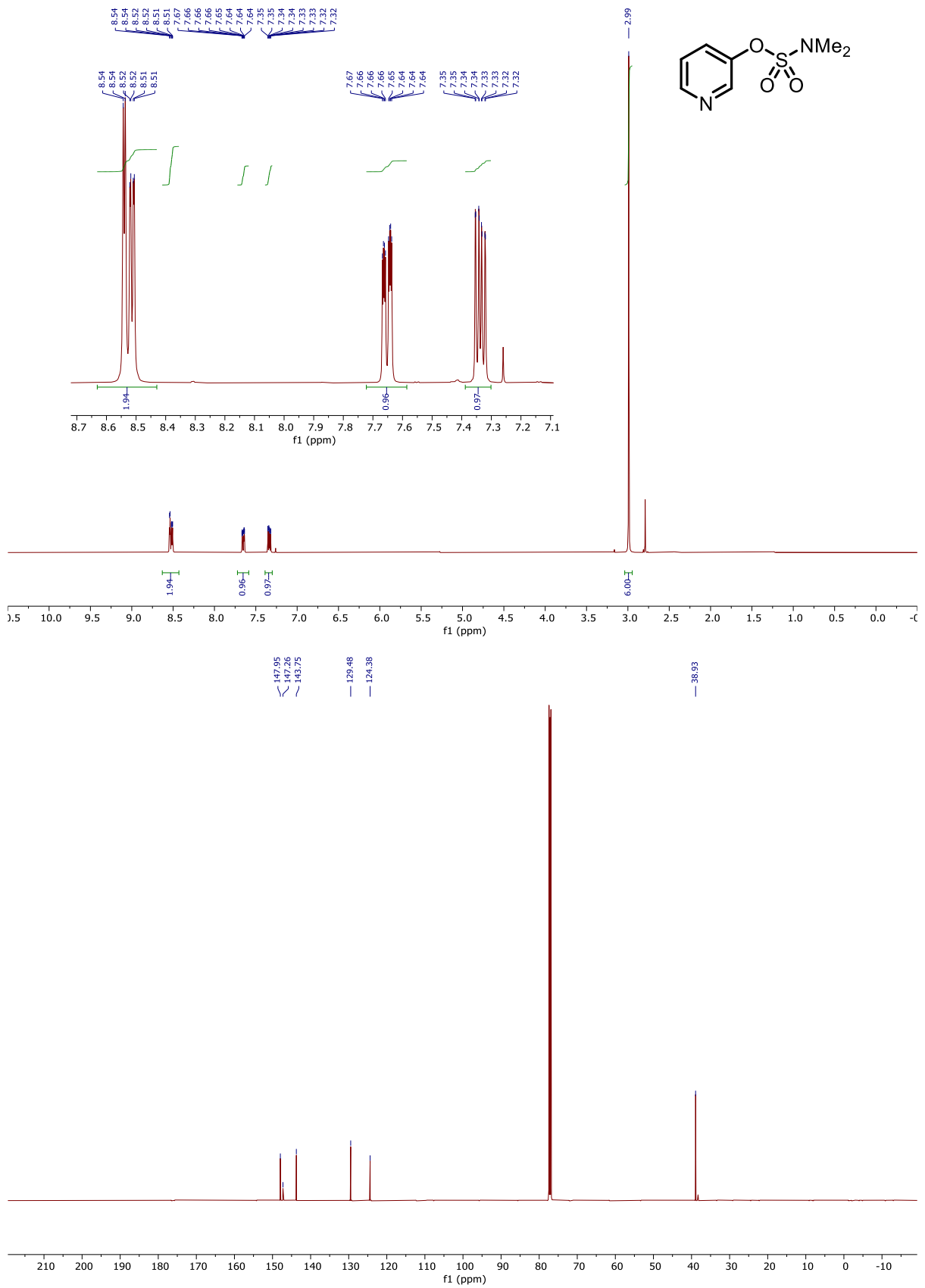

2-hydroxypyridyl dimethylsulfamate (1i)

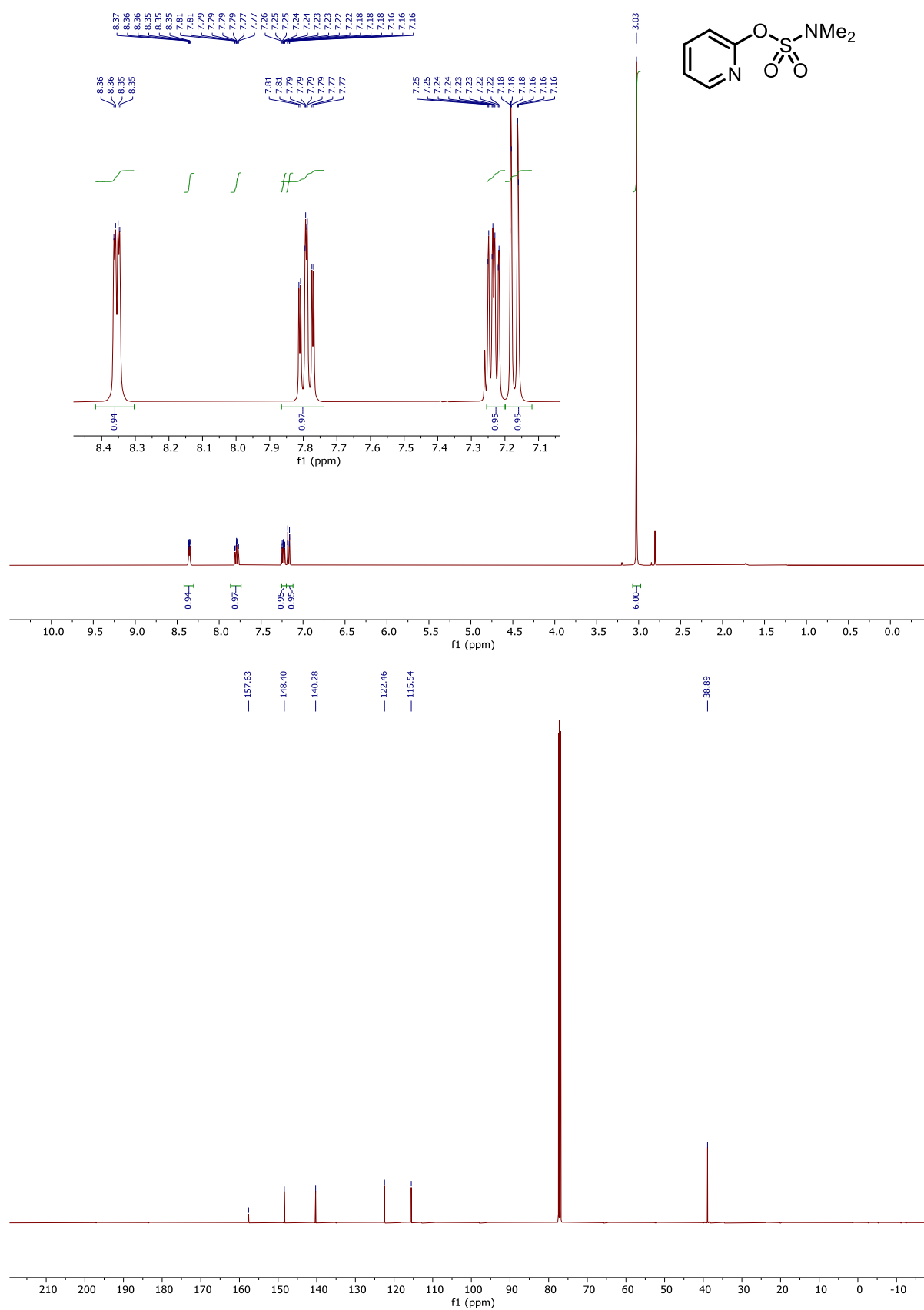

2-(4-fluorophenyl) naphthalene (3a)

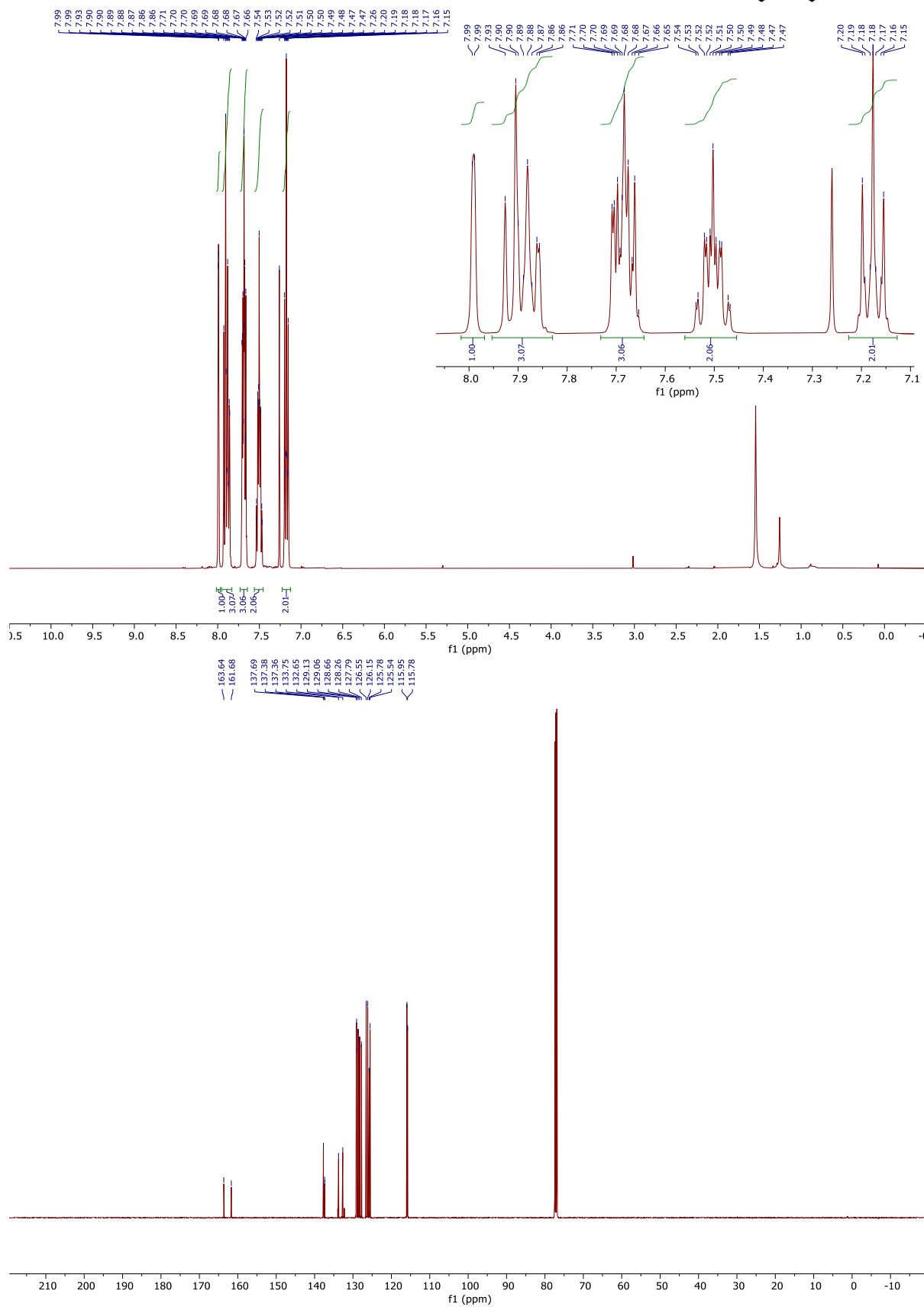
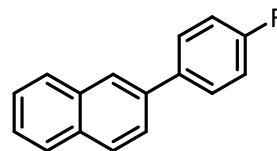

2-phenyl naphthalene (3b)

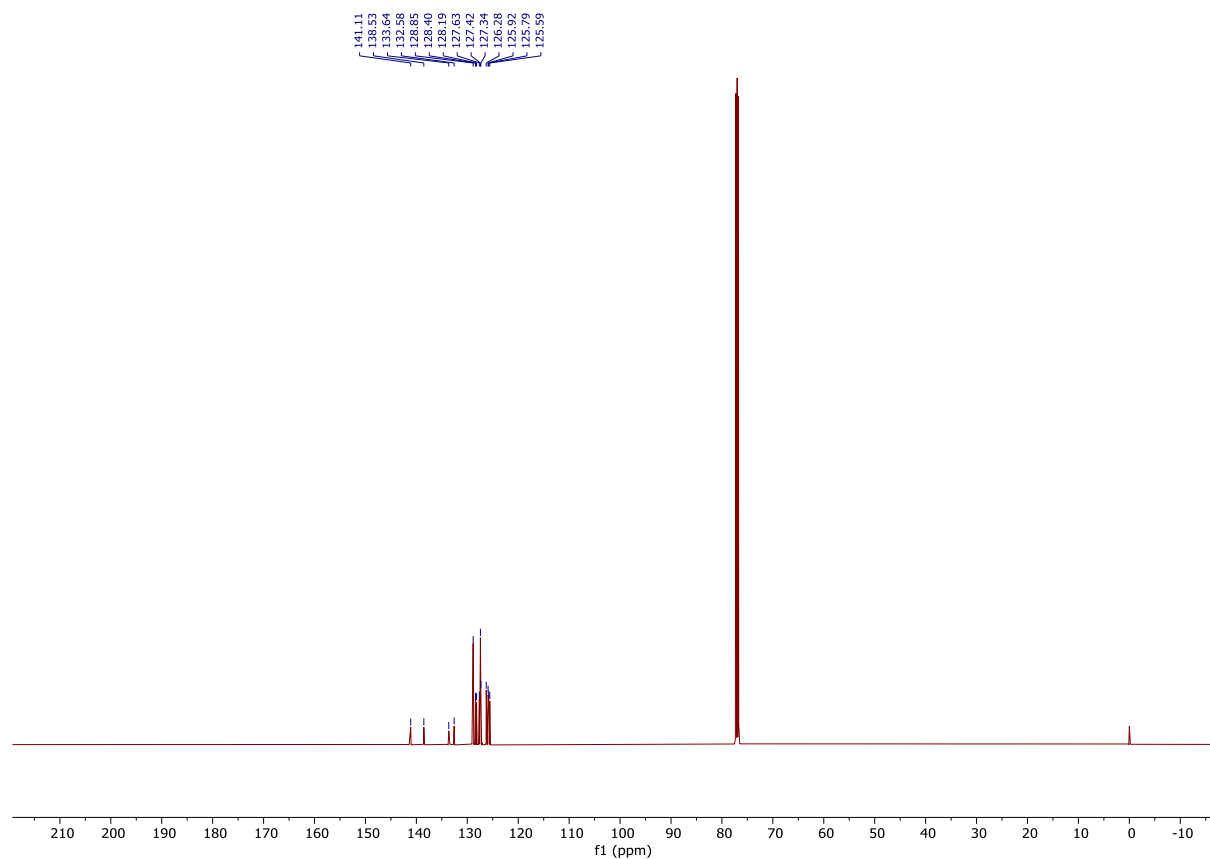
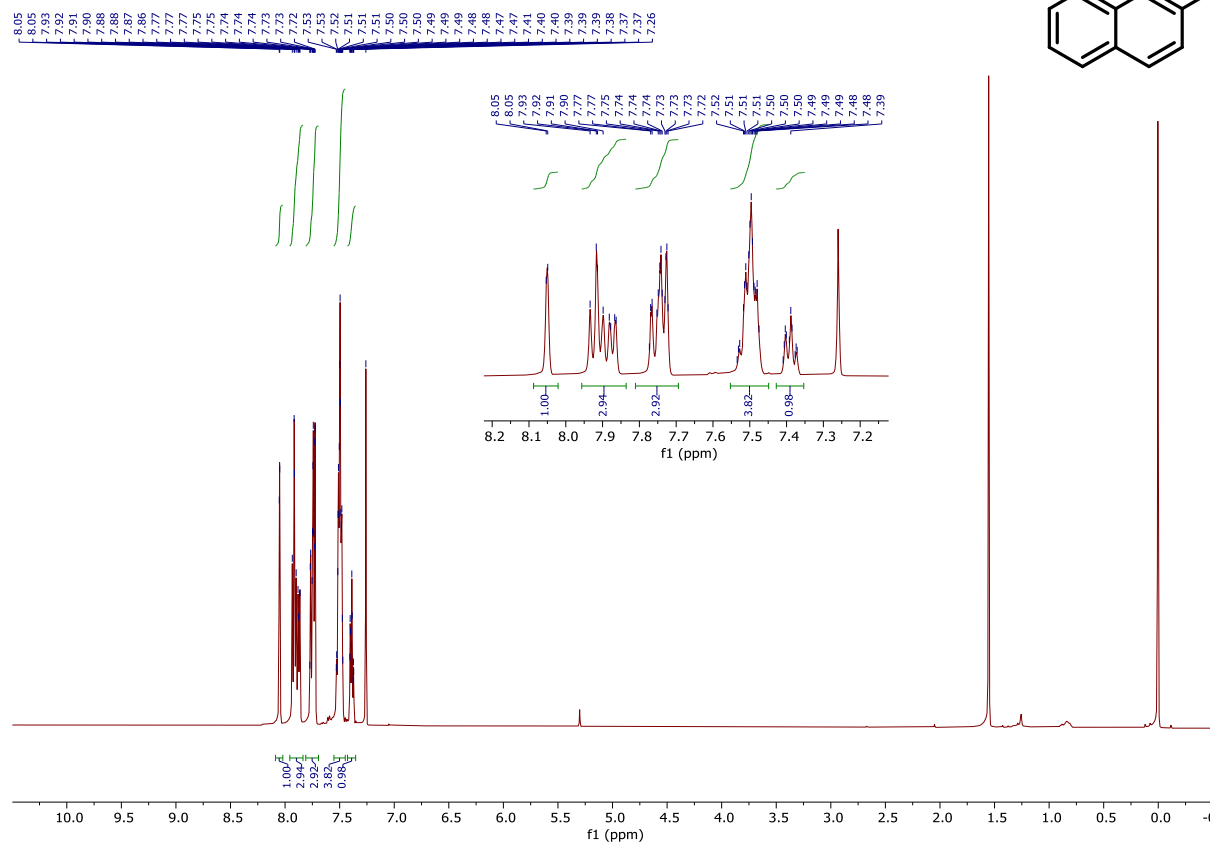
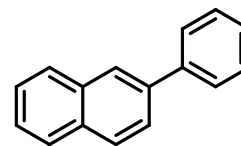

2-(4-methoxyphenyl) naphthalene (3c)

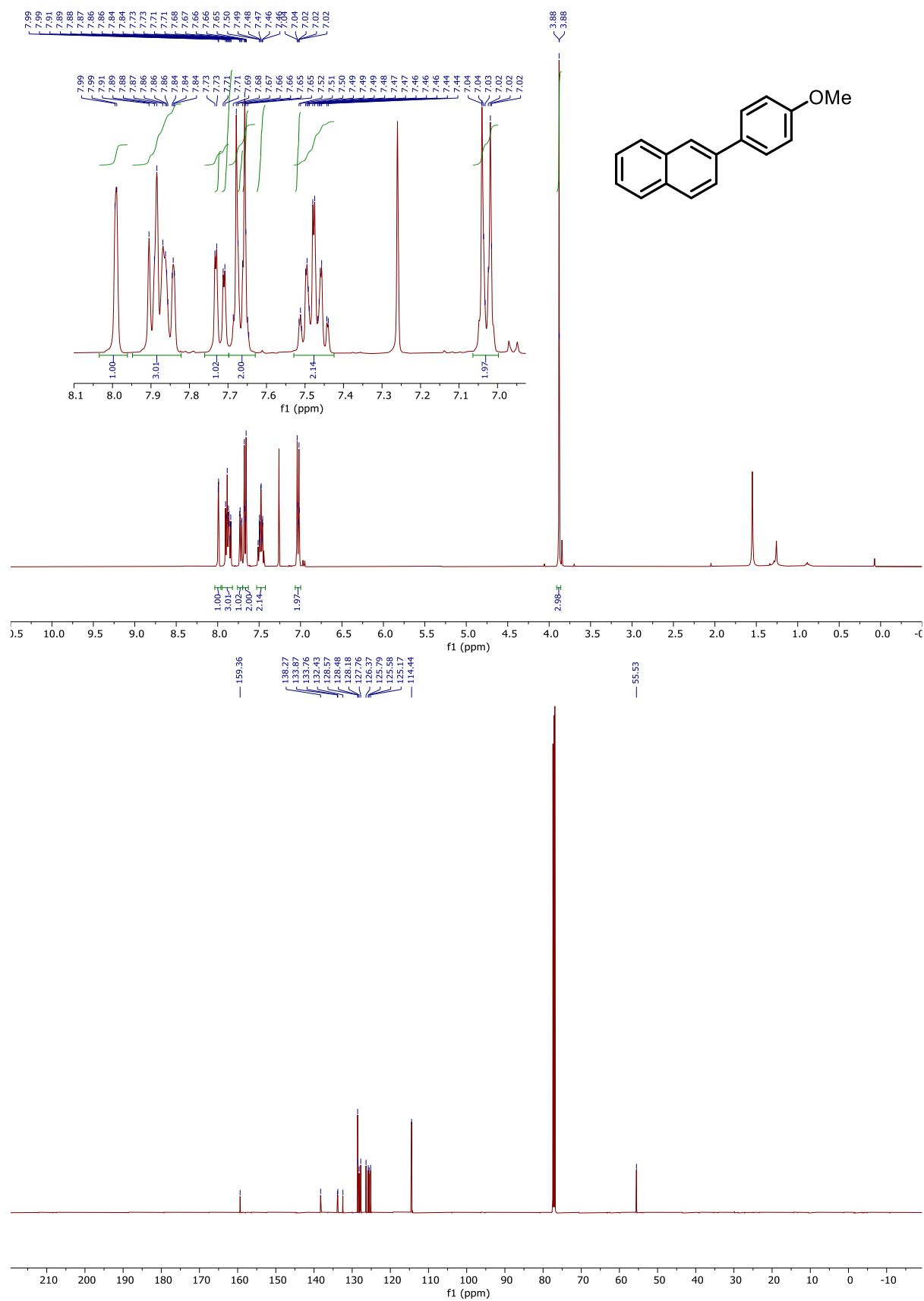

2-(4-isopropoxyphenyl)naphthalene (3f)

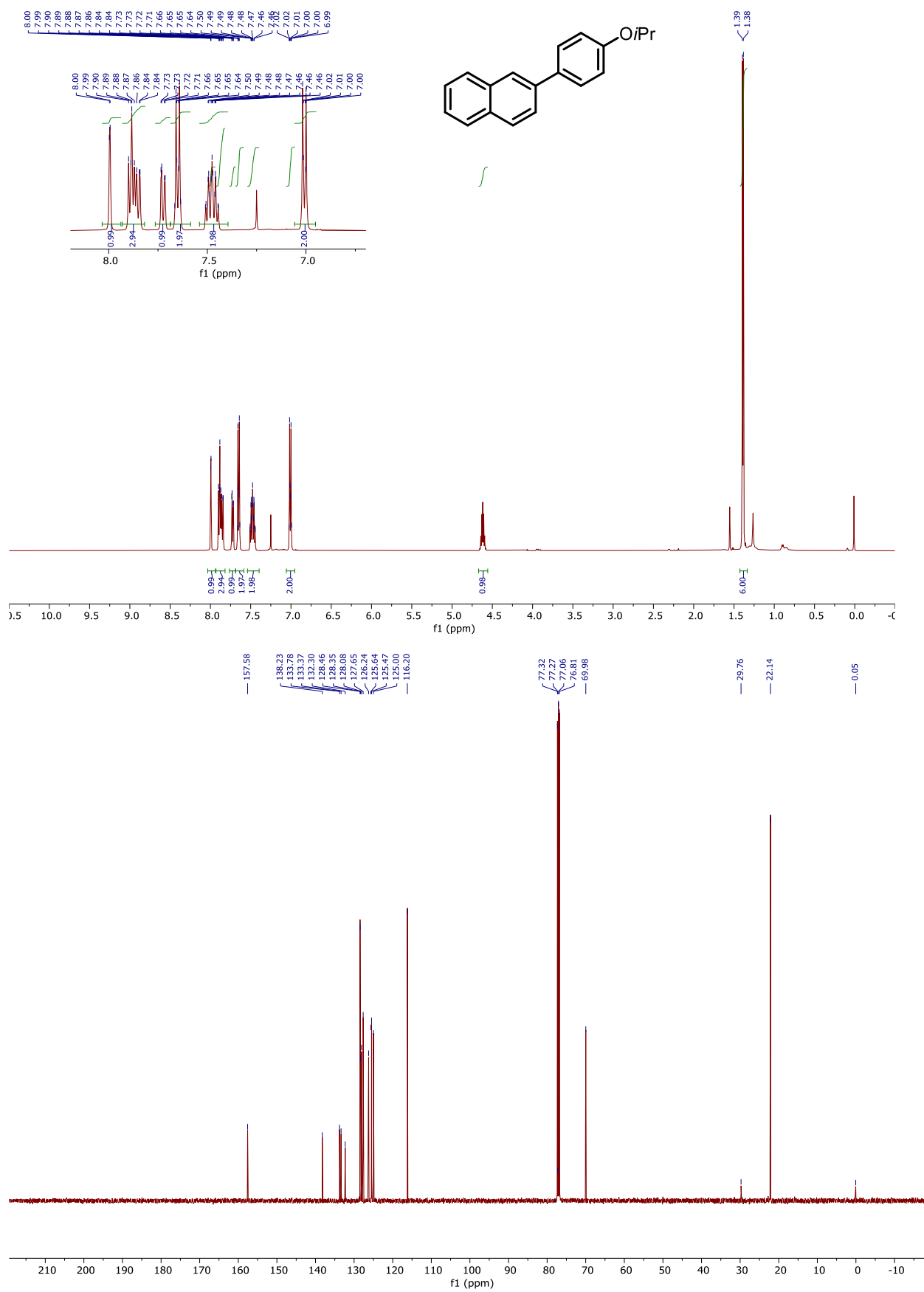

2-(4-Trifluoromethylphenyl) naphthalene (3g)

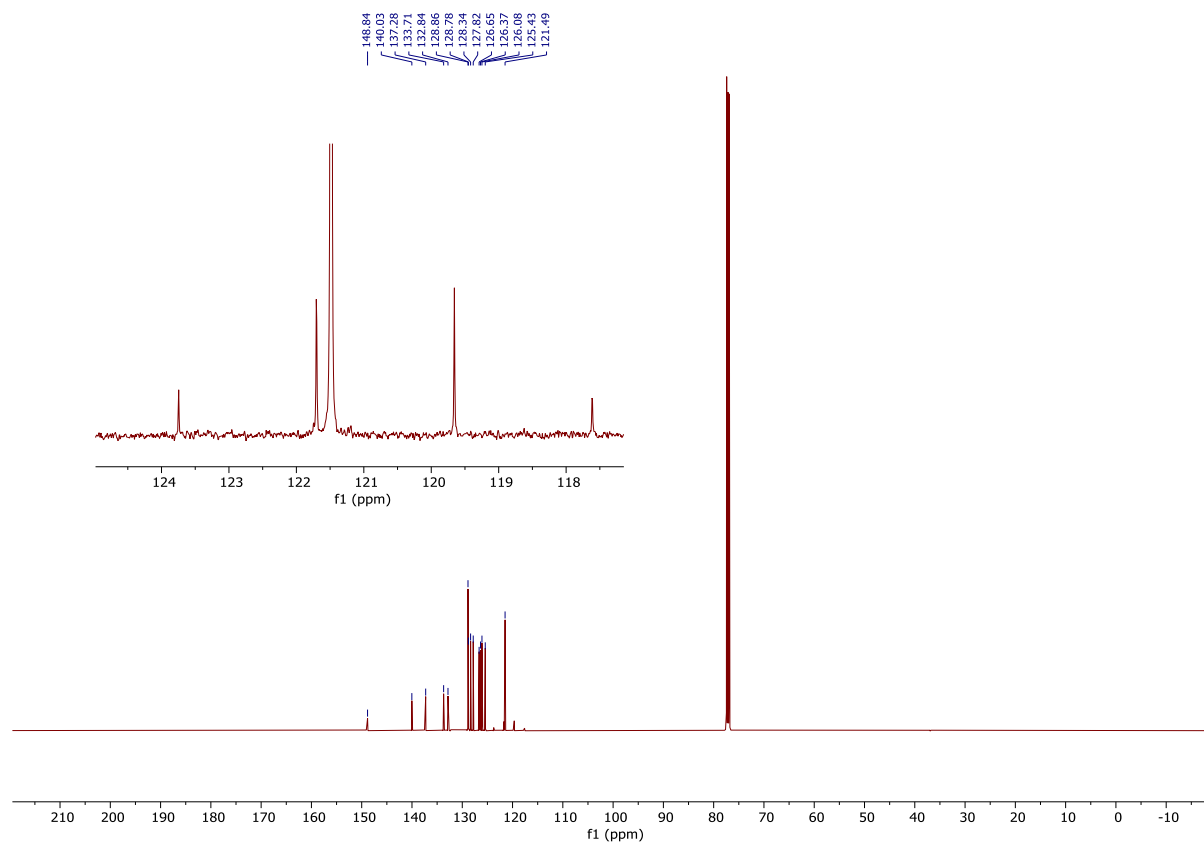
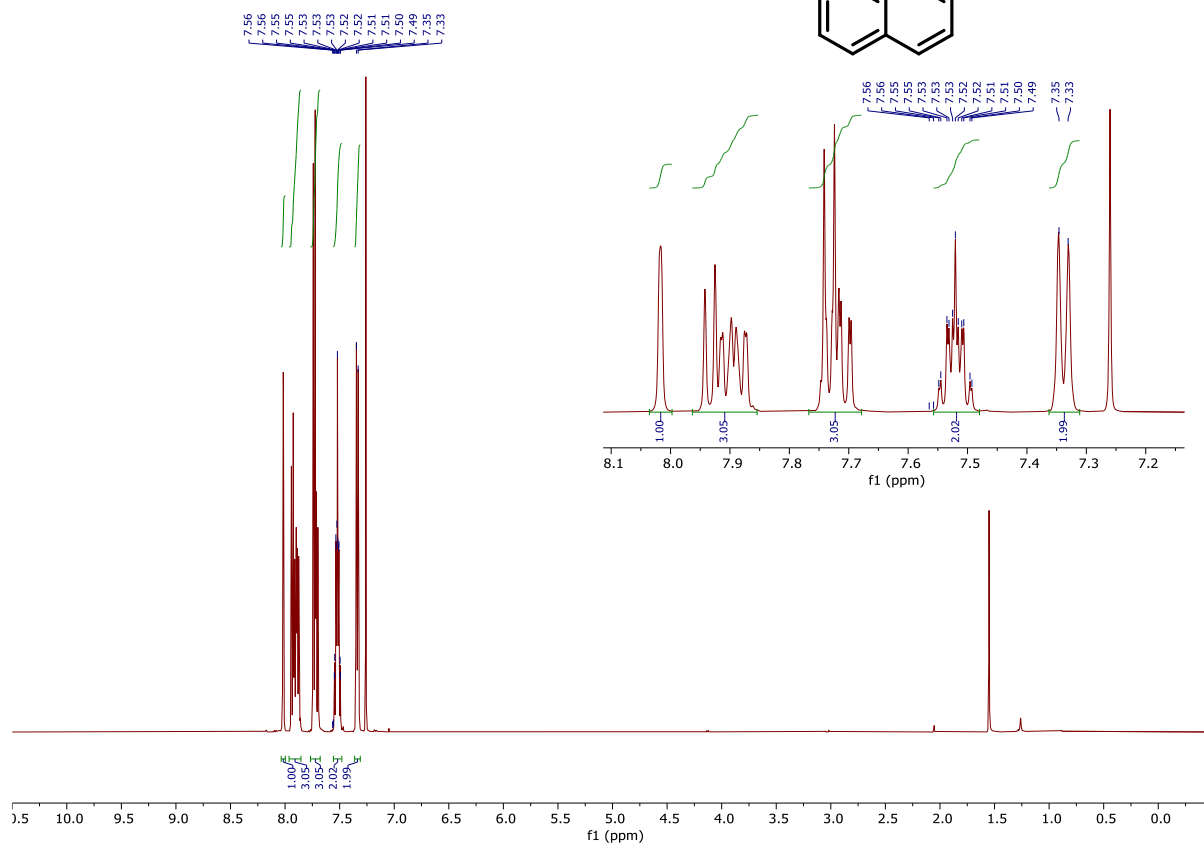
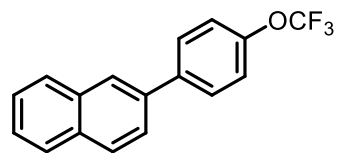

^{19}F NMR (659 MHz, CDCl_3)

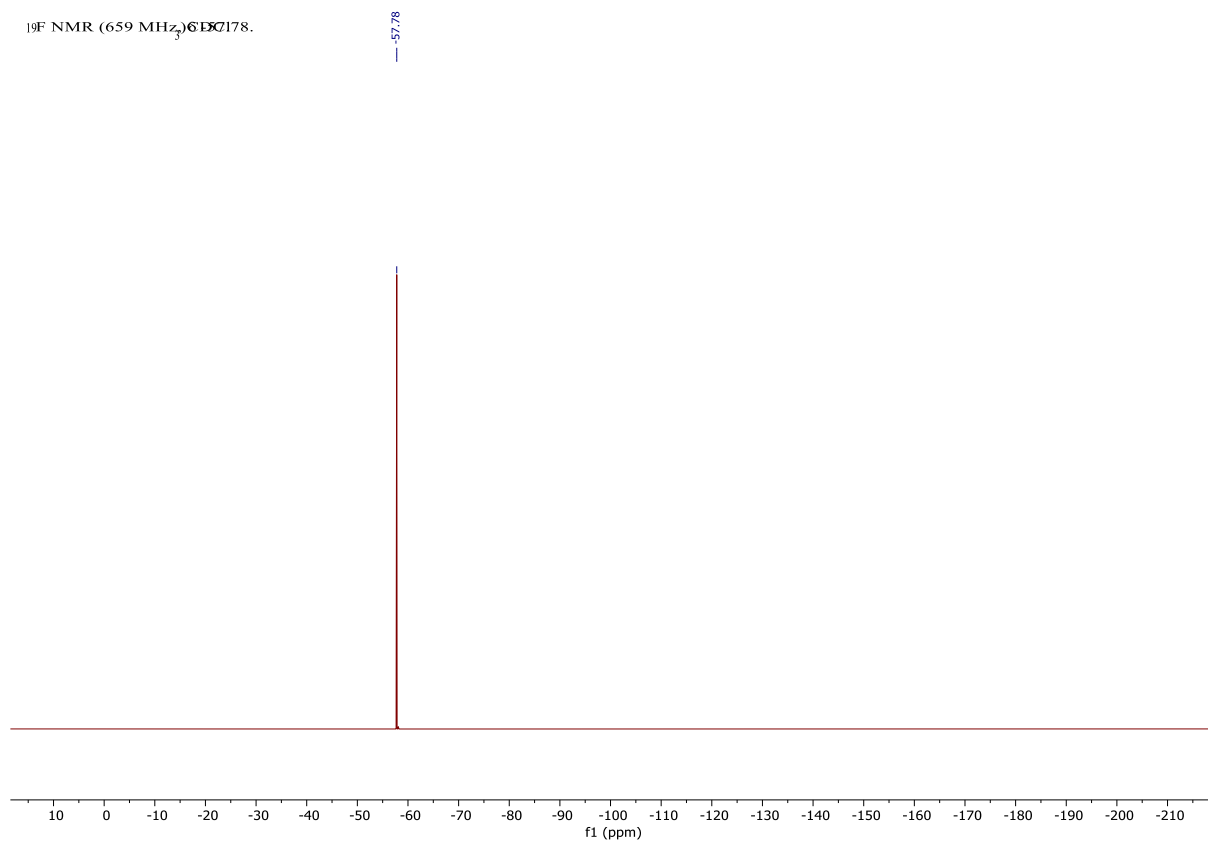

2-(4-methylphenyl) naphthalene (3h)

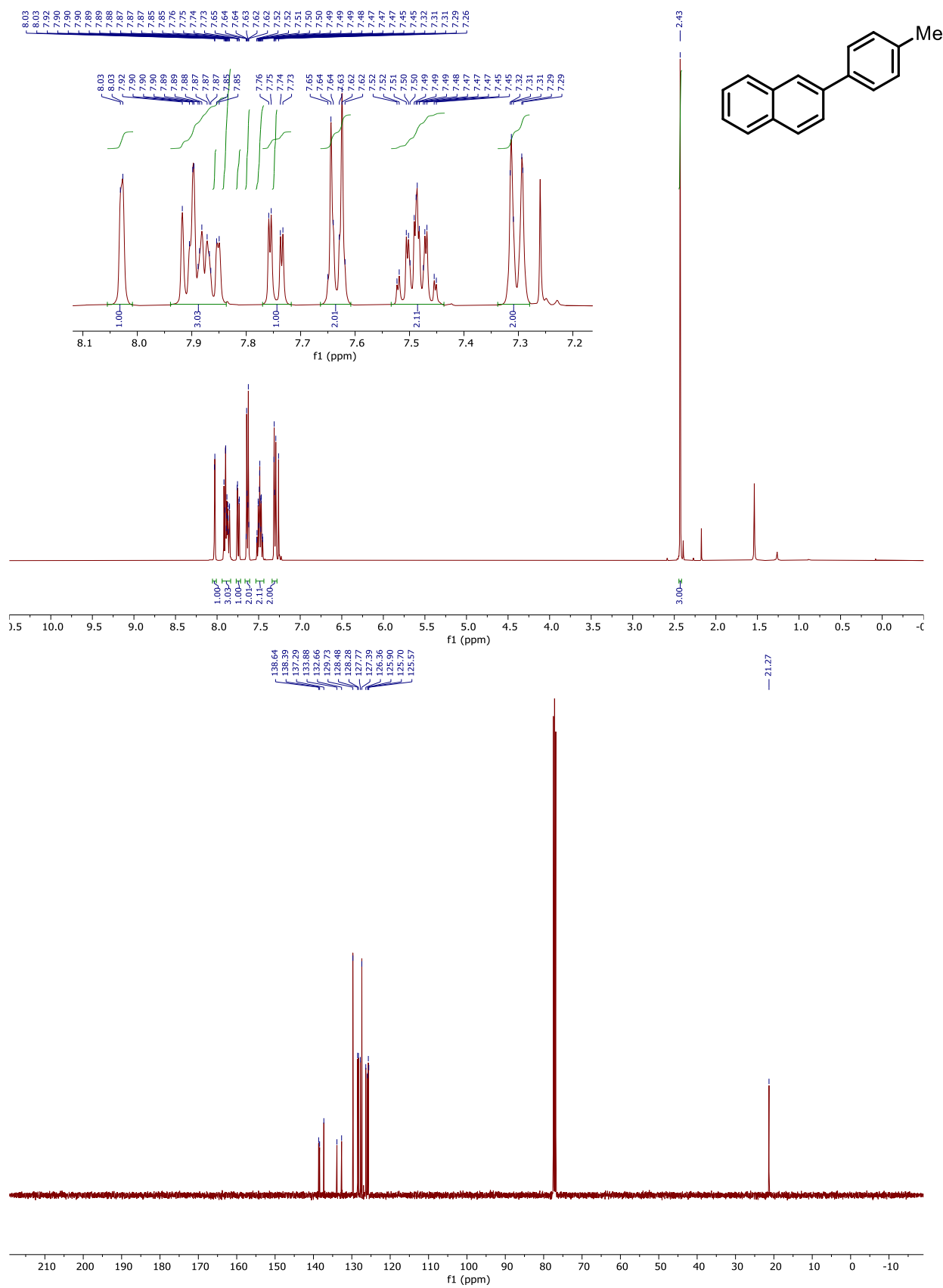

2-(4-tert-butylphenyl) naphthalene (3j)

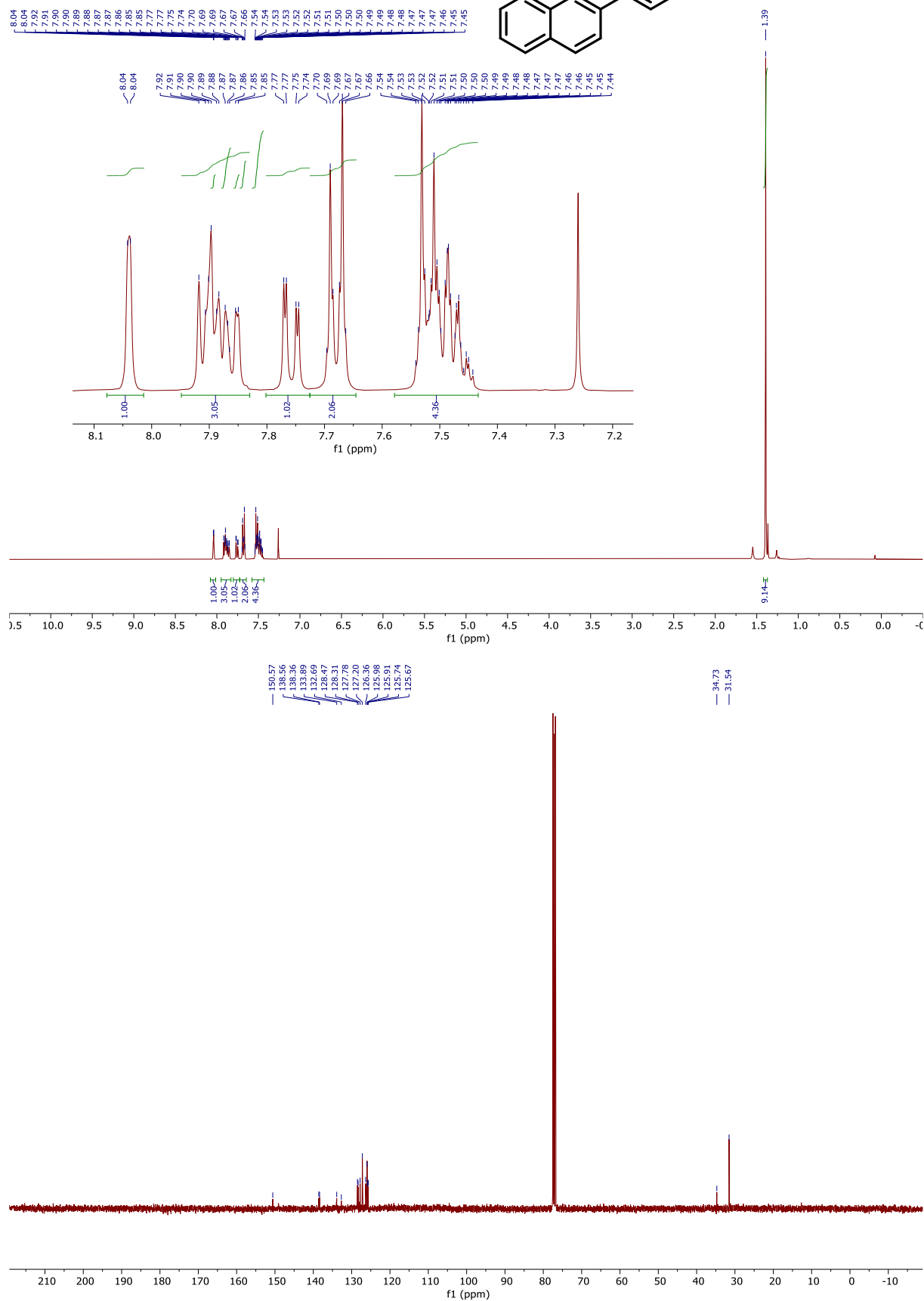
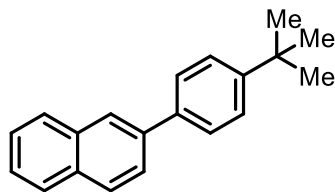

2-(4-Acetylphenyl) naphthalene (3k)

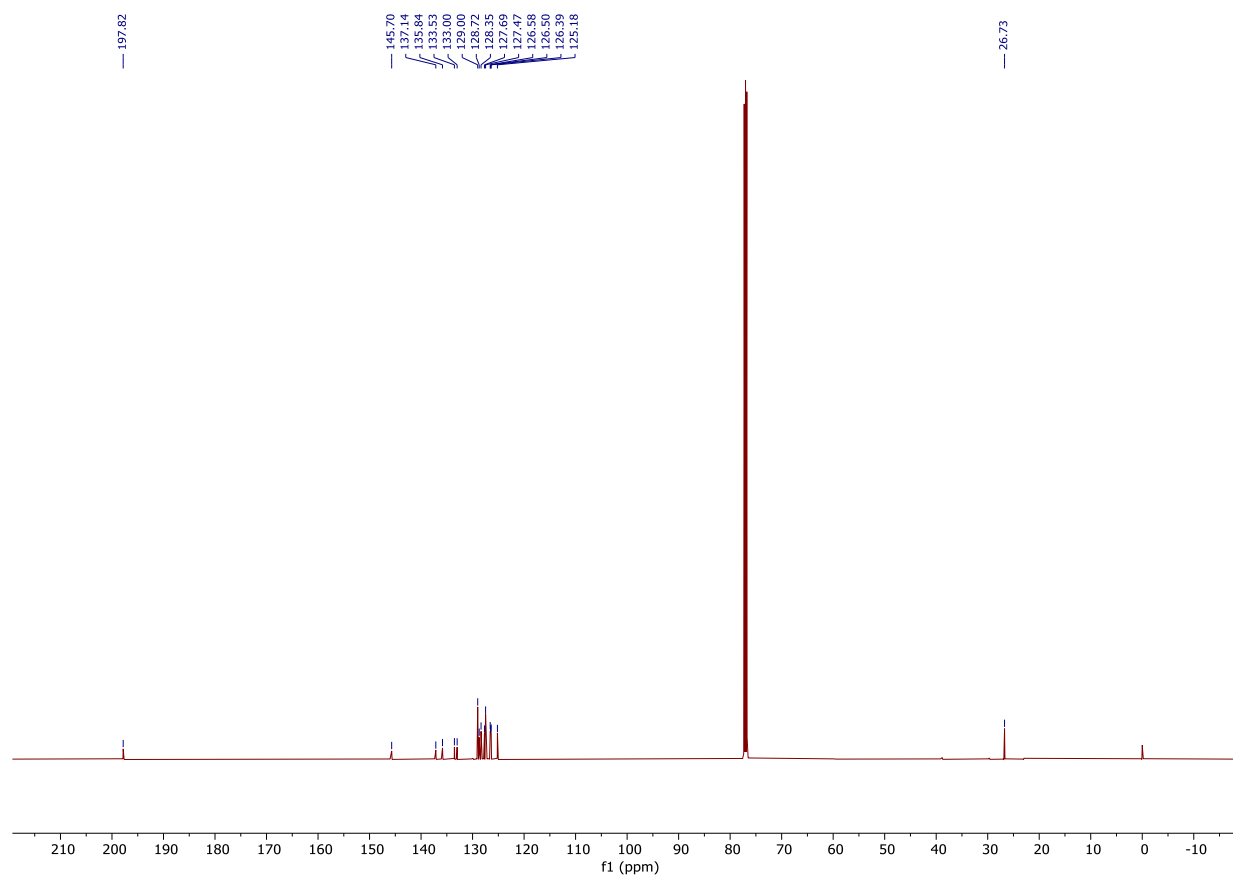
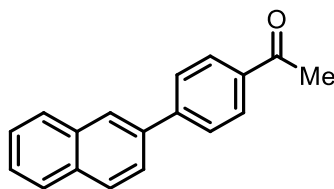
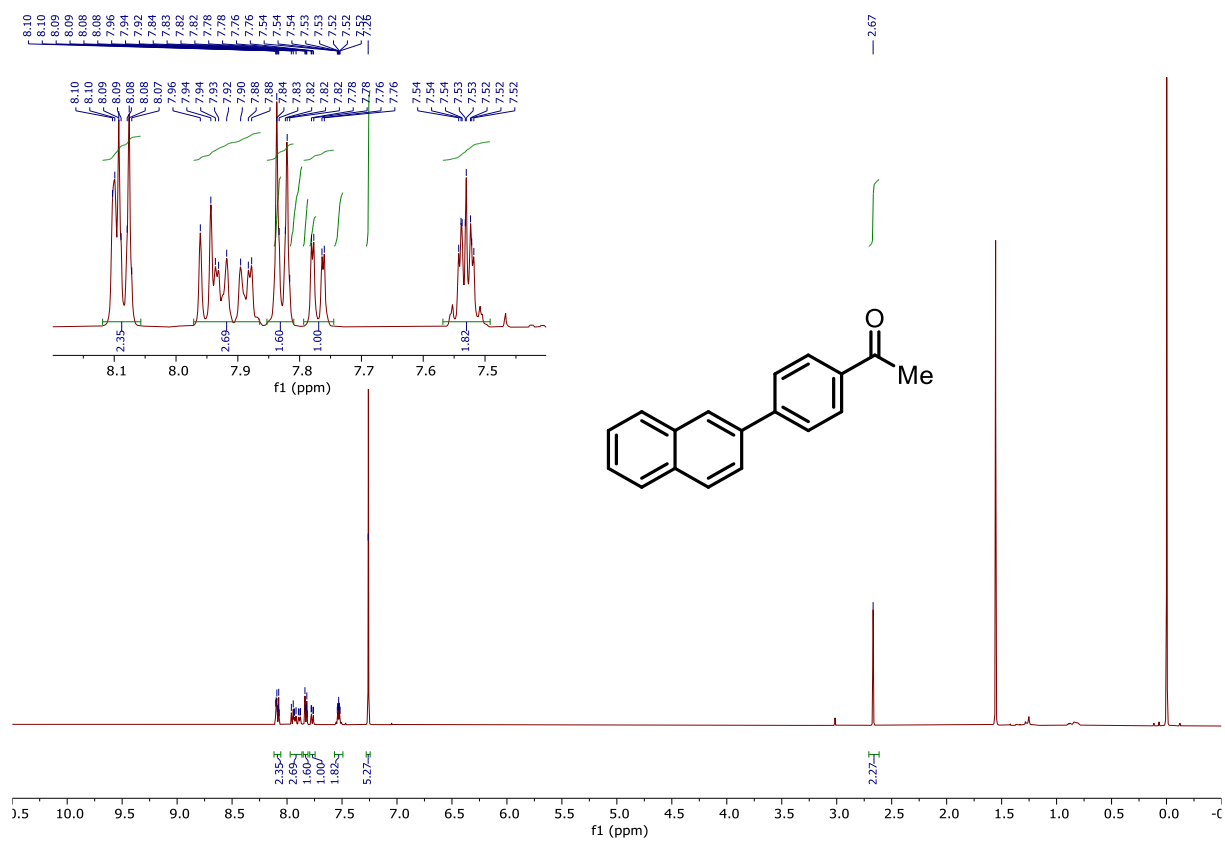

2-(4-ethoxycarbonylphenyl) naphthalene (3l)

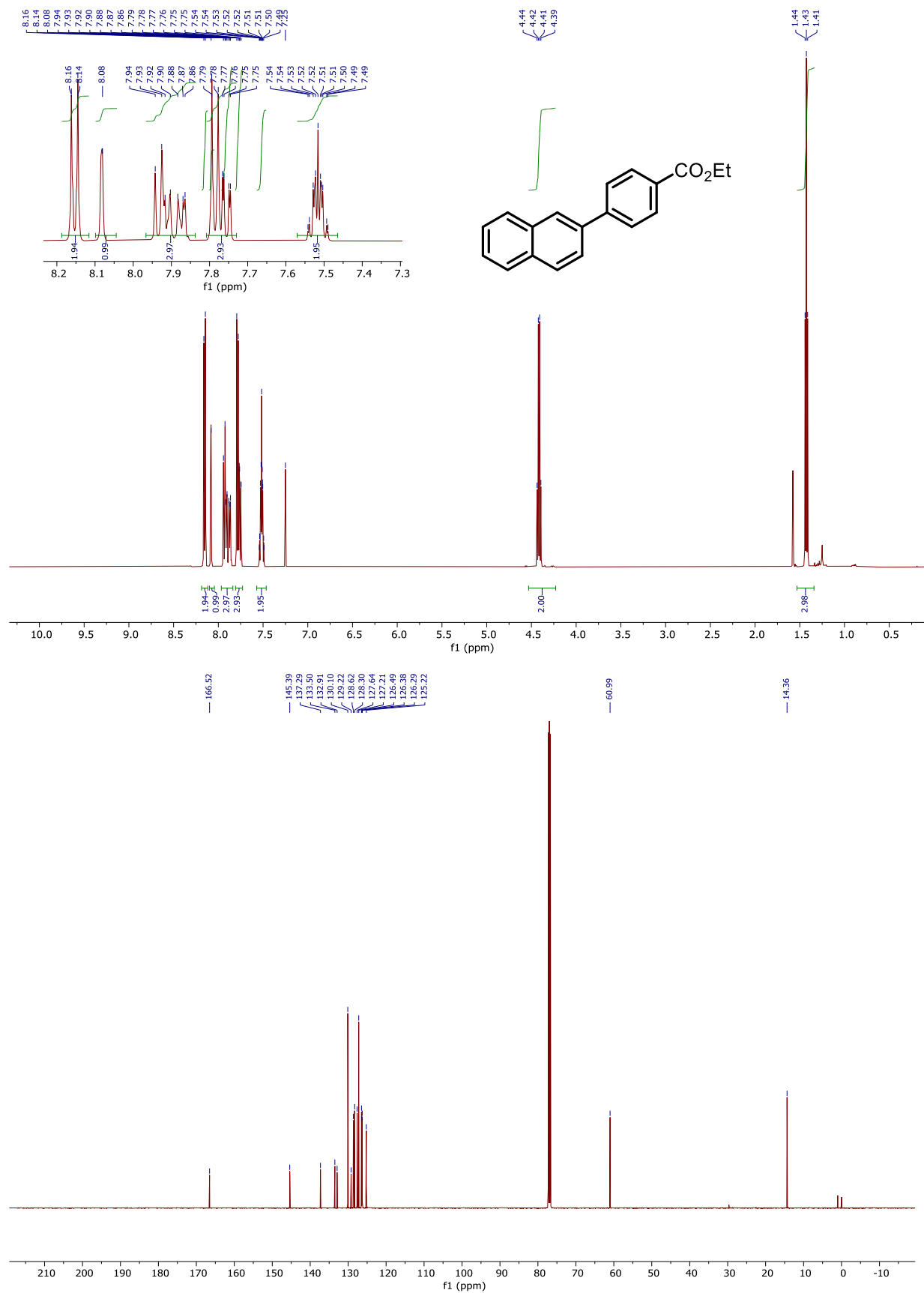

2-(4-trifluorophenyl) naphthalene (3m)

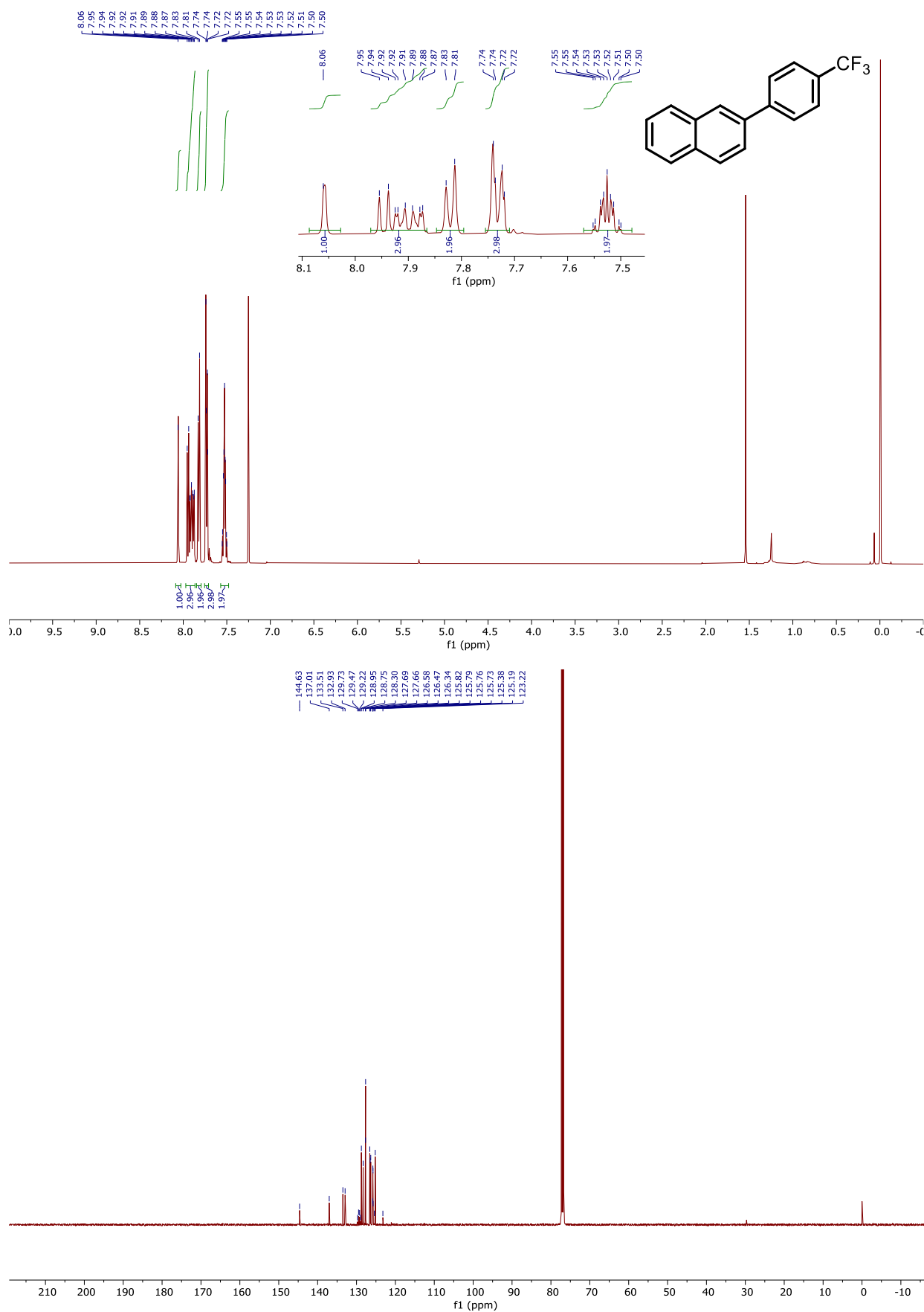

2-(4-cyanophenyl) naphthalene (3n)

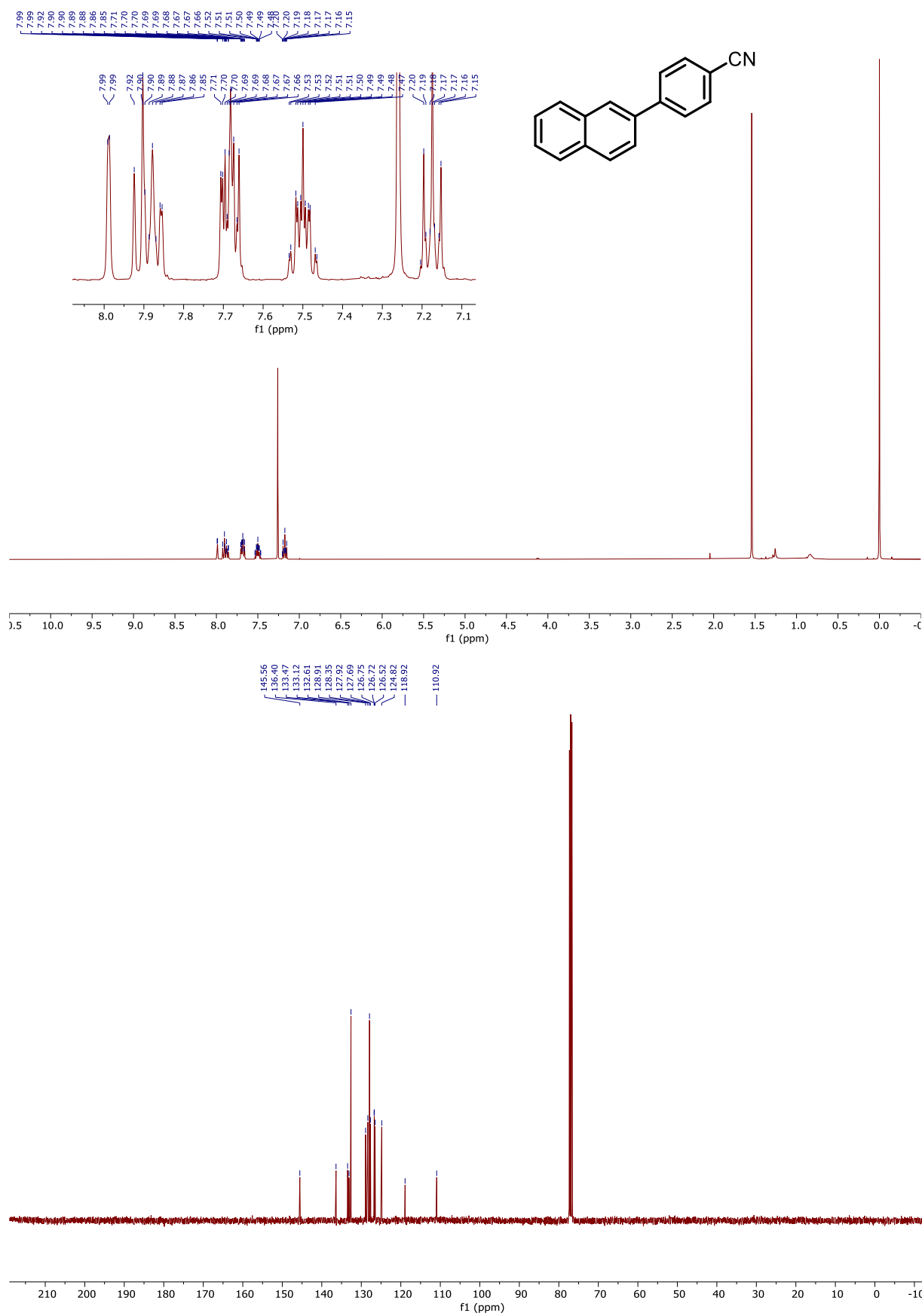

3-(dibenzo[b,d]thiophen-2-yl)pyridine (3q)

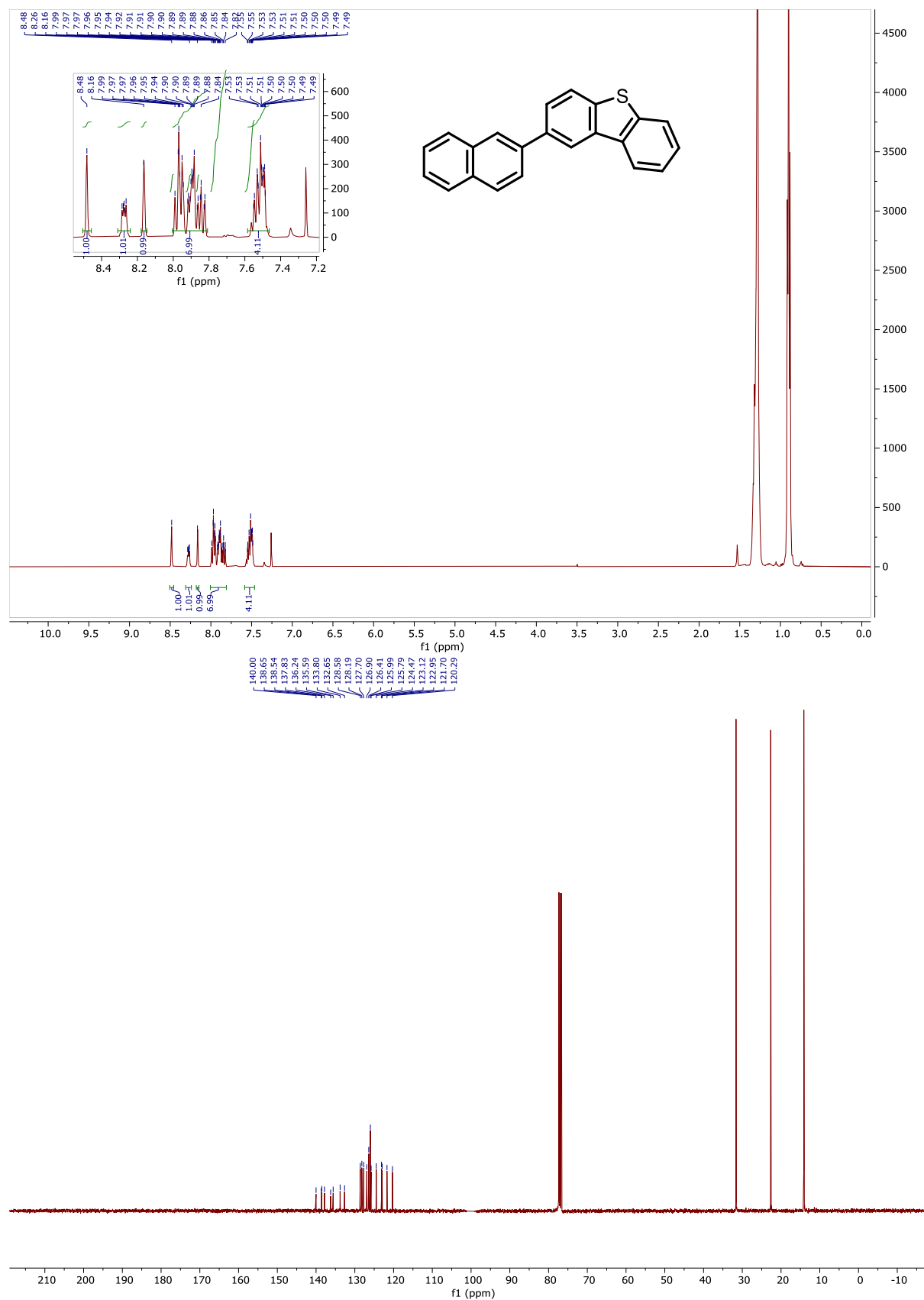

**residual hexane in NMR. Protodeboronated dibenzothiophene co-elutes with C-C coupled product. Cleanest fractions shown. Values given in main text are NMR yields.

1-(4-Fluorophenyl)naphthalene (3d)

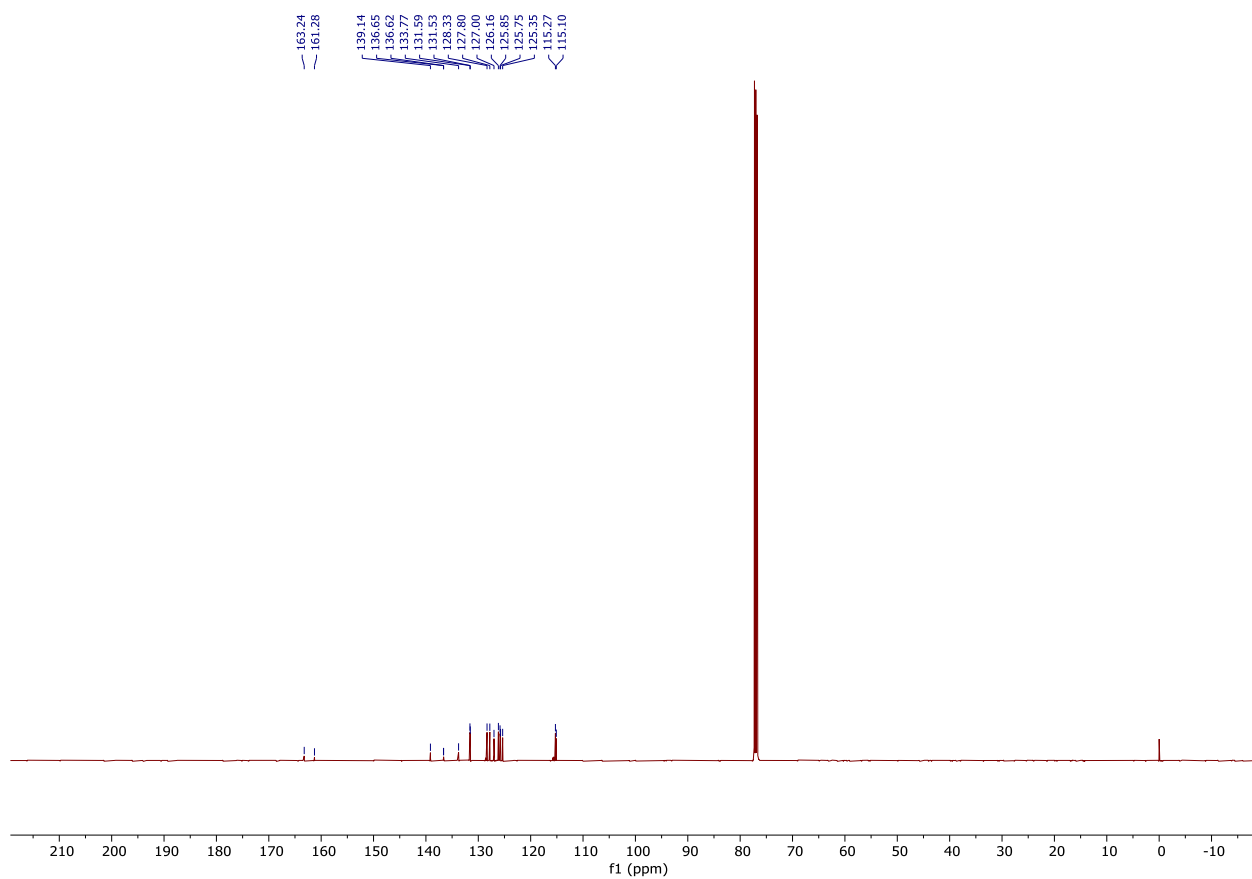
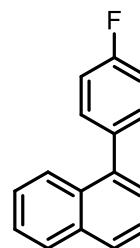
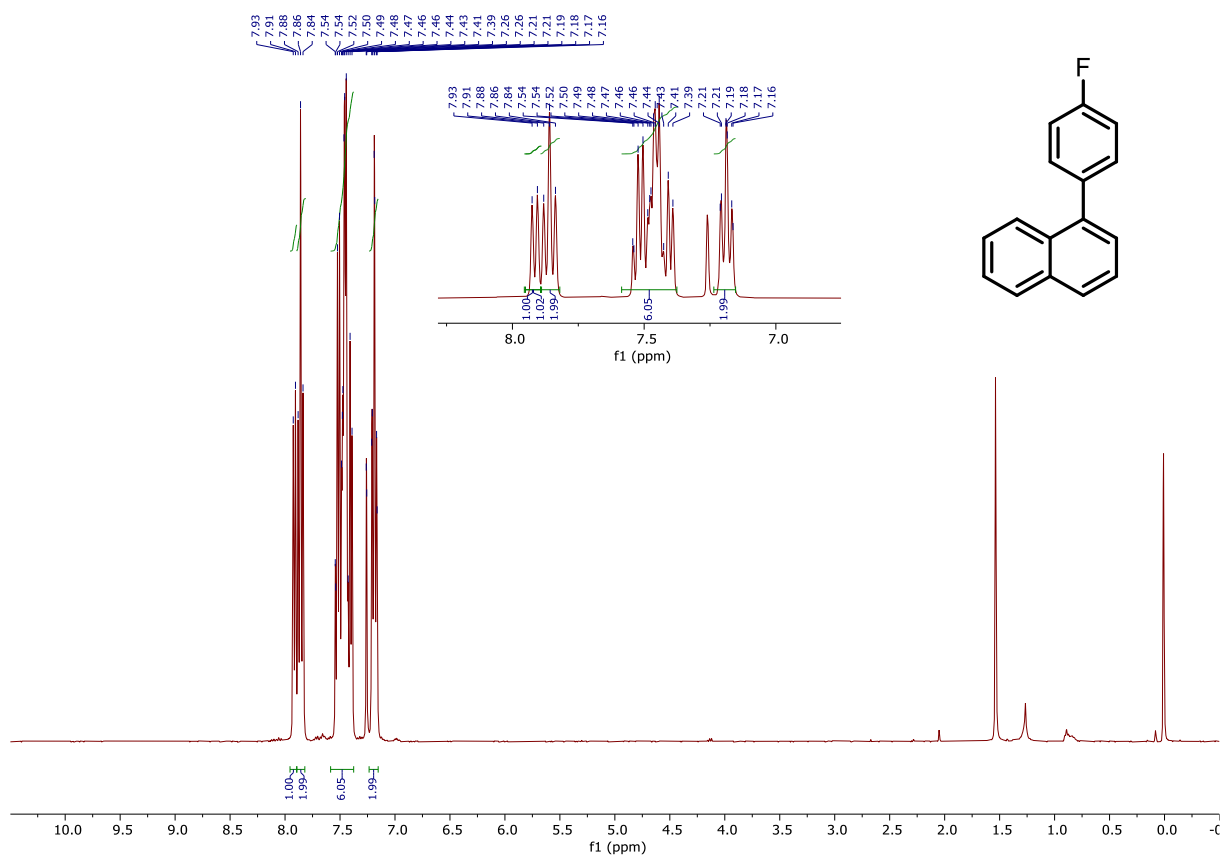

4-Fluoro-1,1':4',1''-terphenyl (3e)

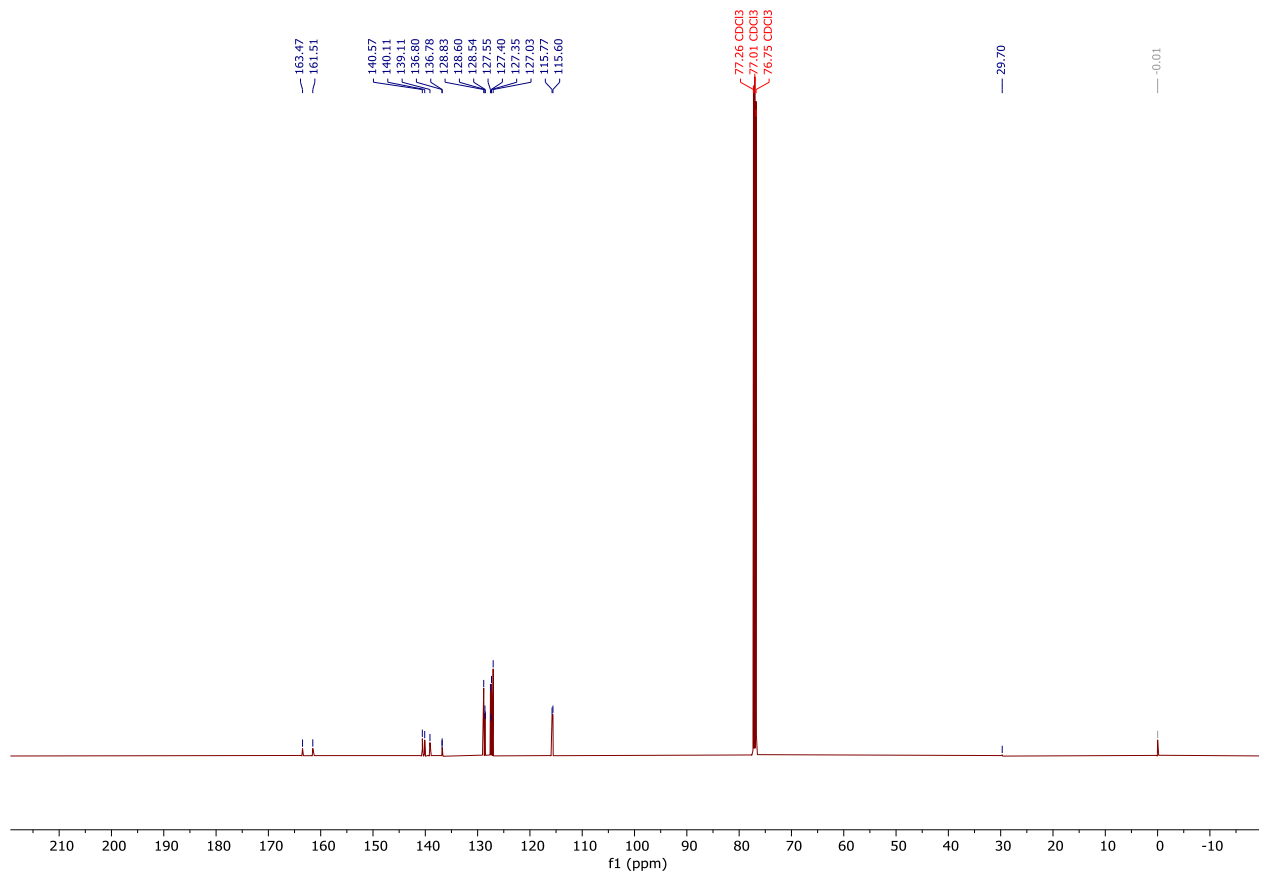
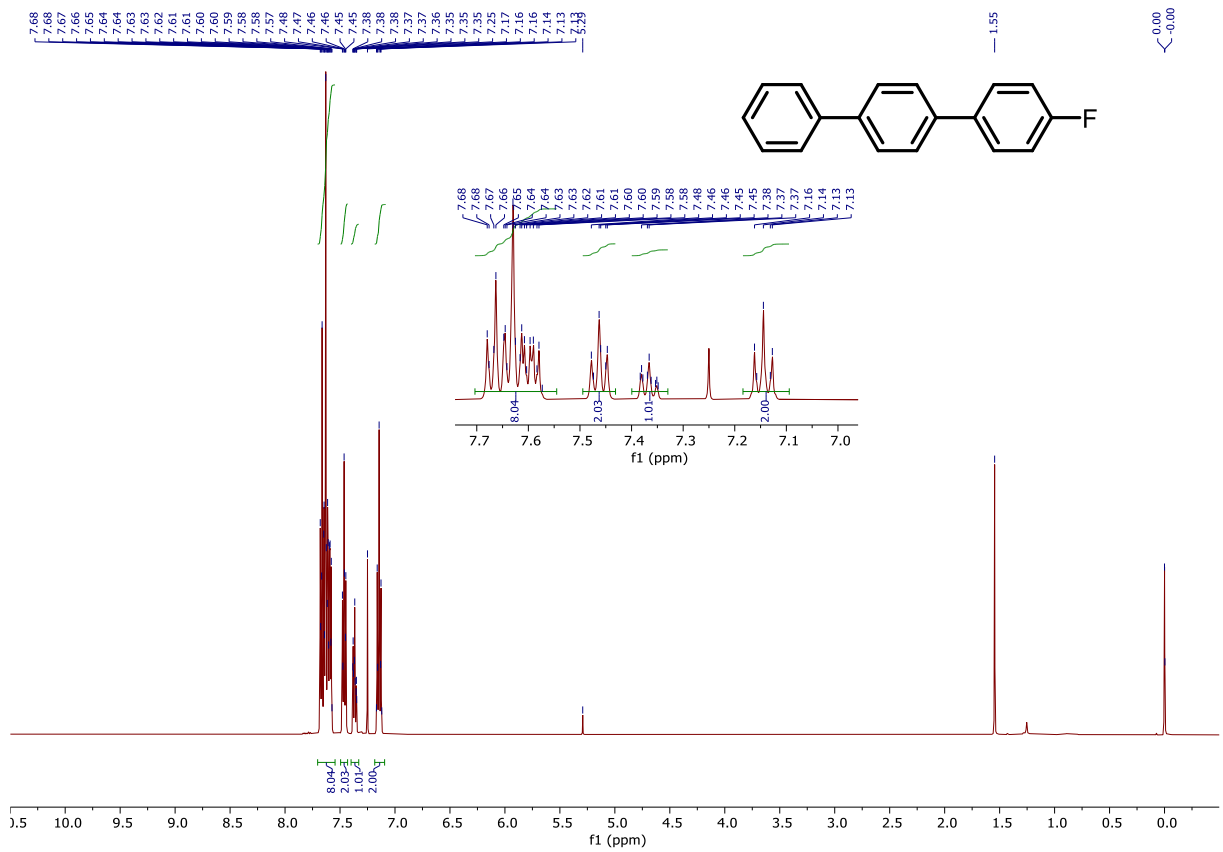

1-(4-fluorophenyl)-4-methoxynaphthalene (3r)

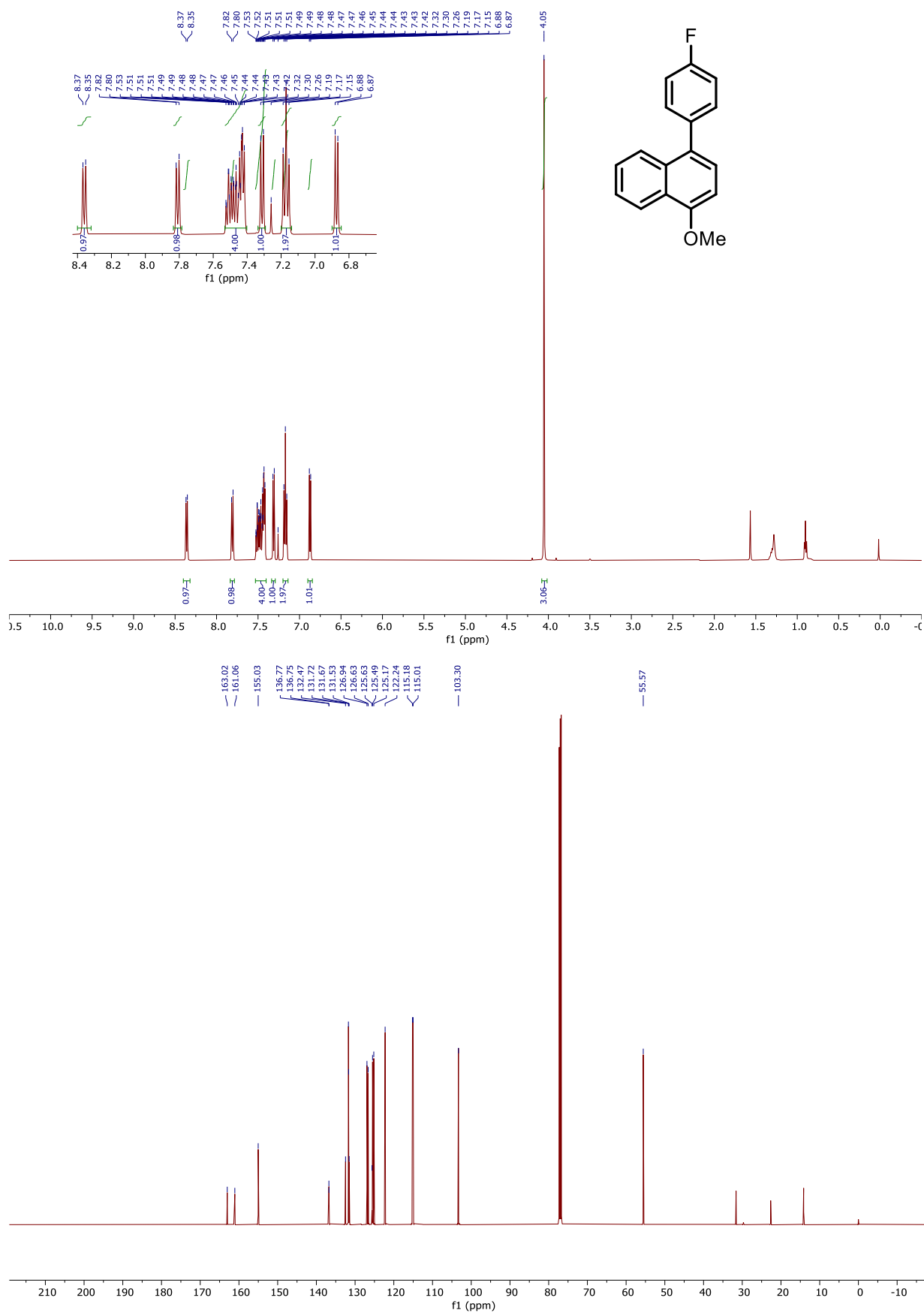

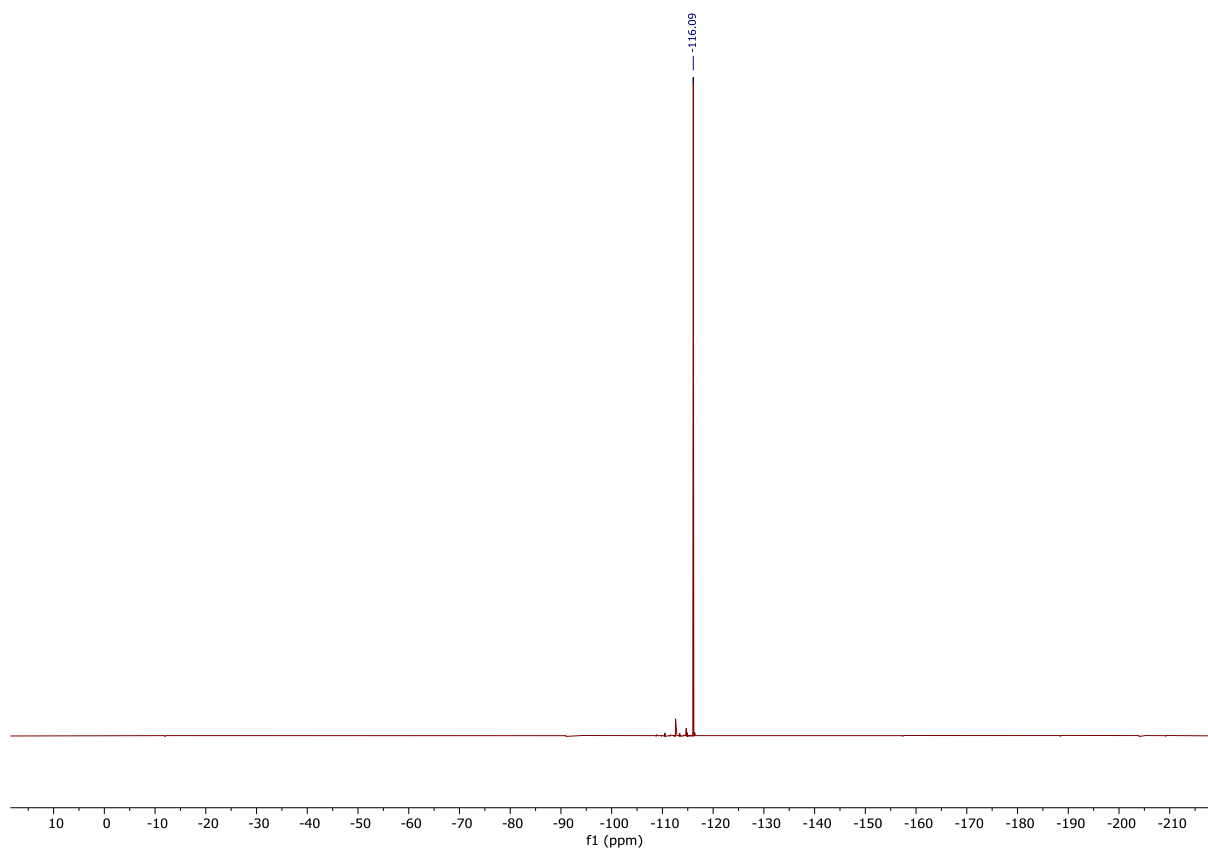

Preparation of 4-fluoro-4'-methoxy-1,1'-biphenyl (3s)

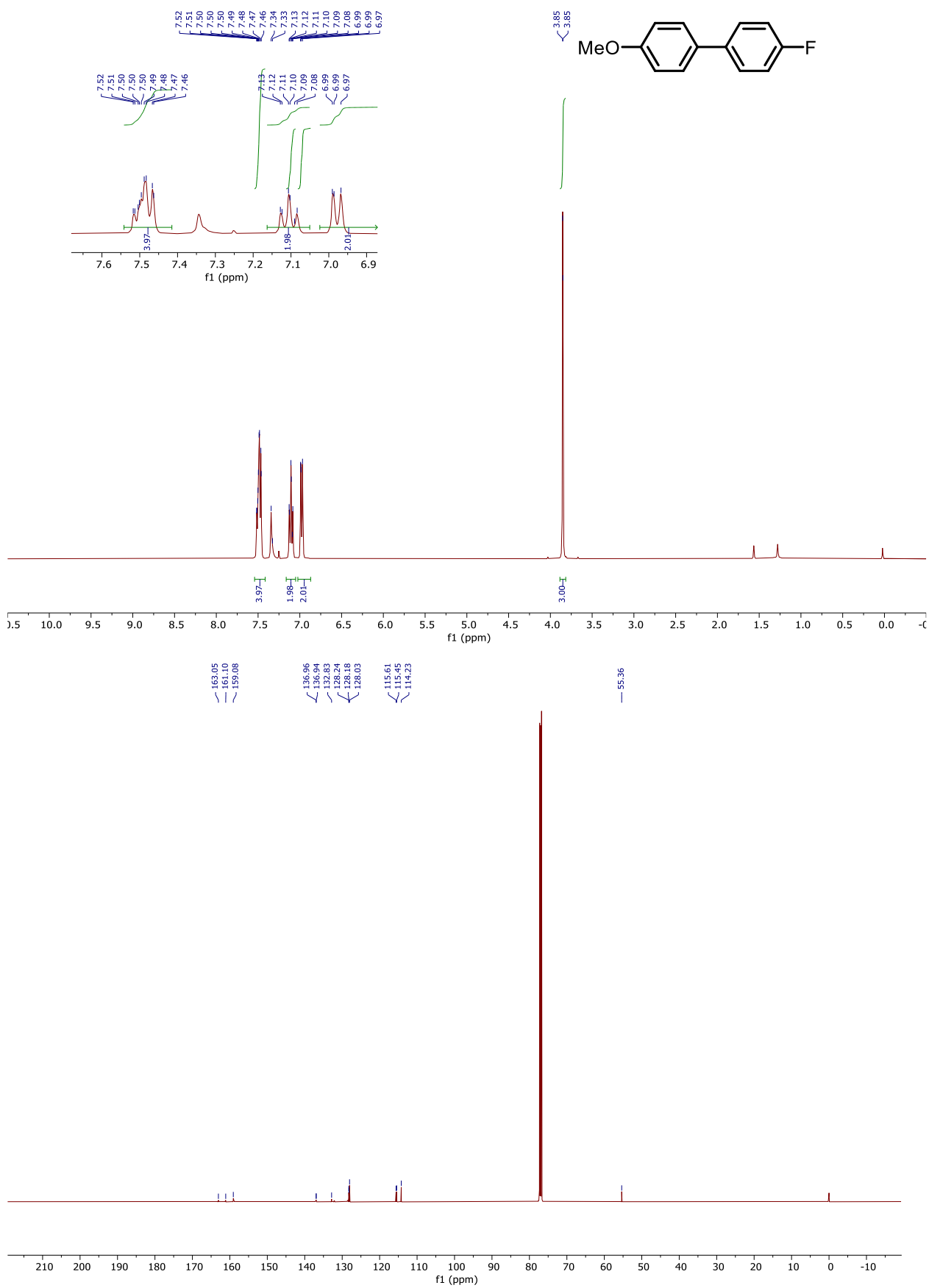

4'-fluoro-[1,1'-biphenyl]-4-carbonitrile (3t)

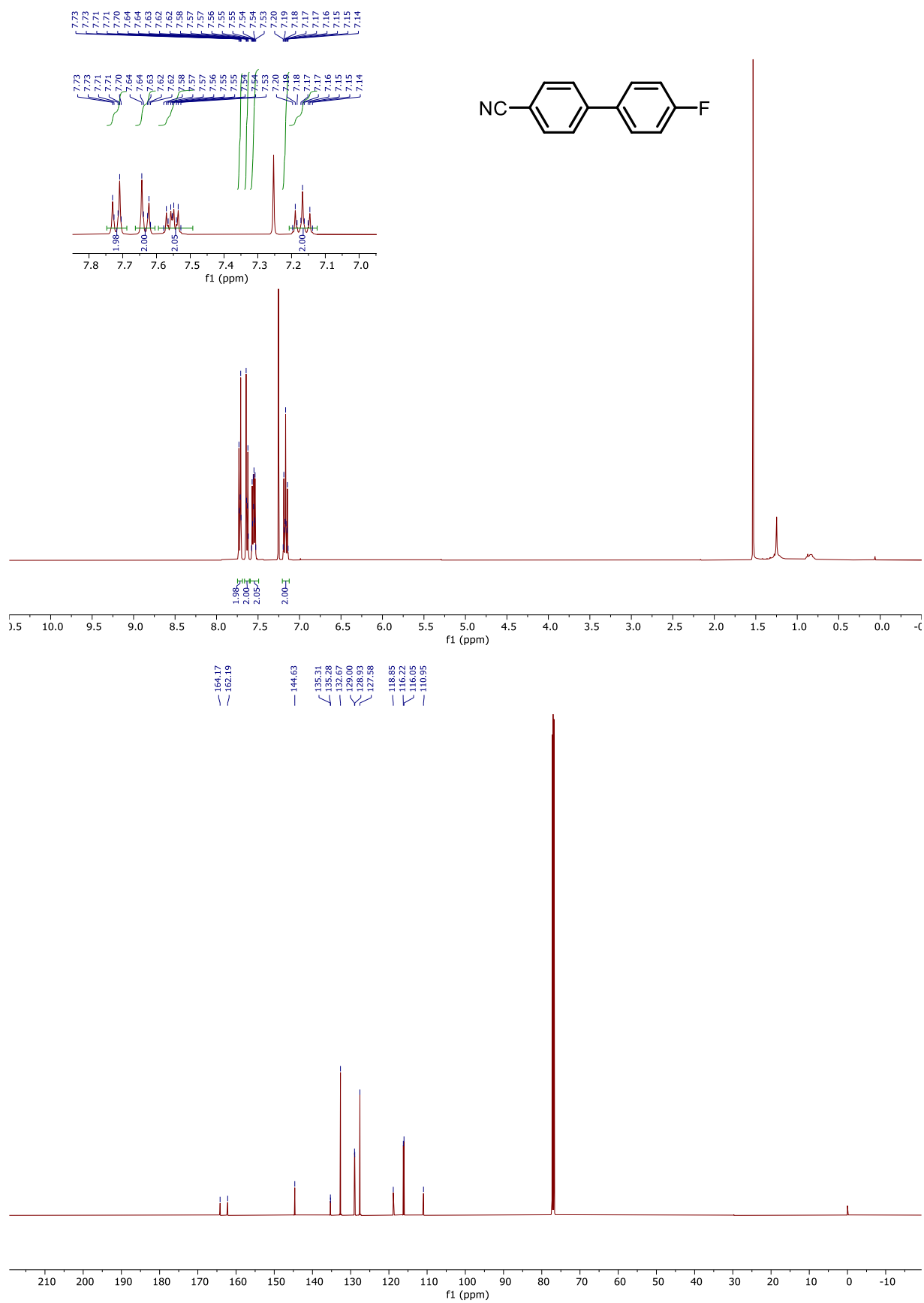

Methyl 4'-fluoro-[1,1'-biphenyl]-4-carboxylate (3u)

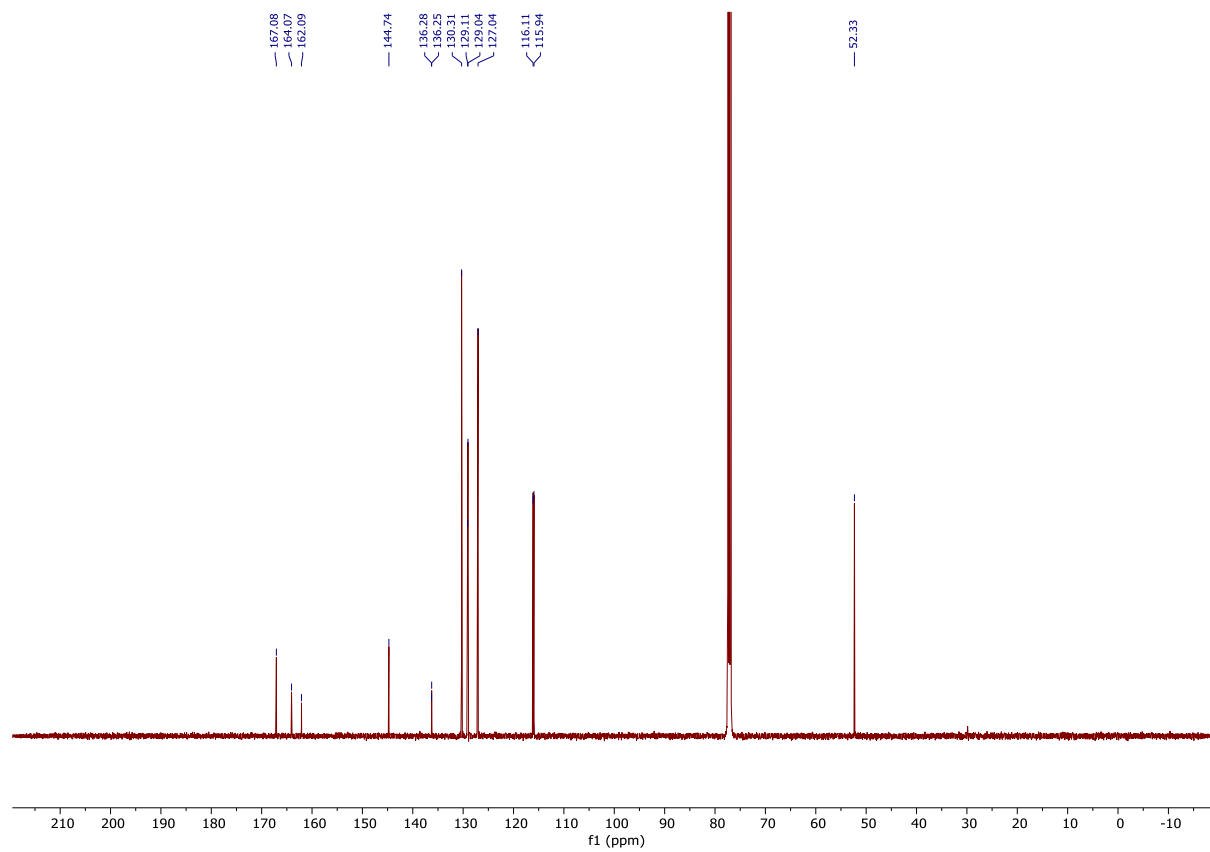
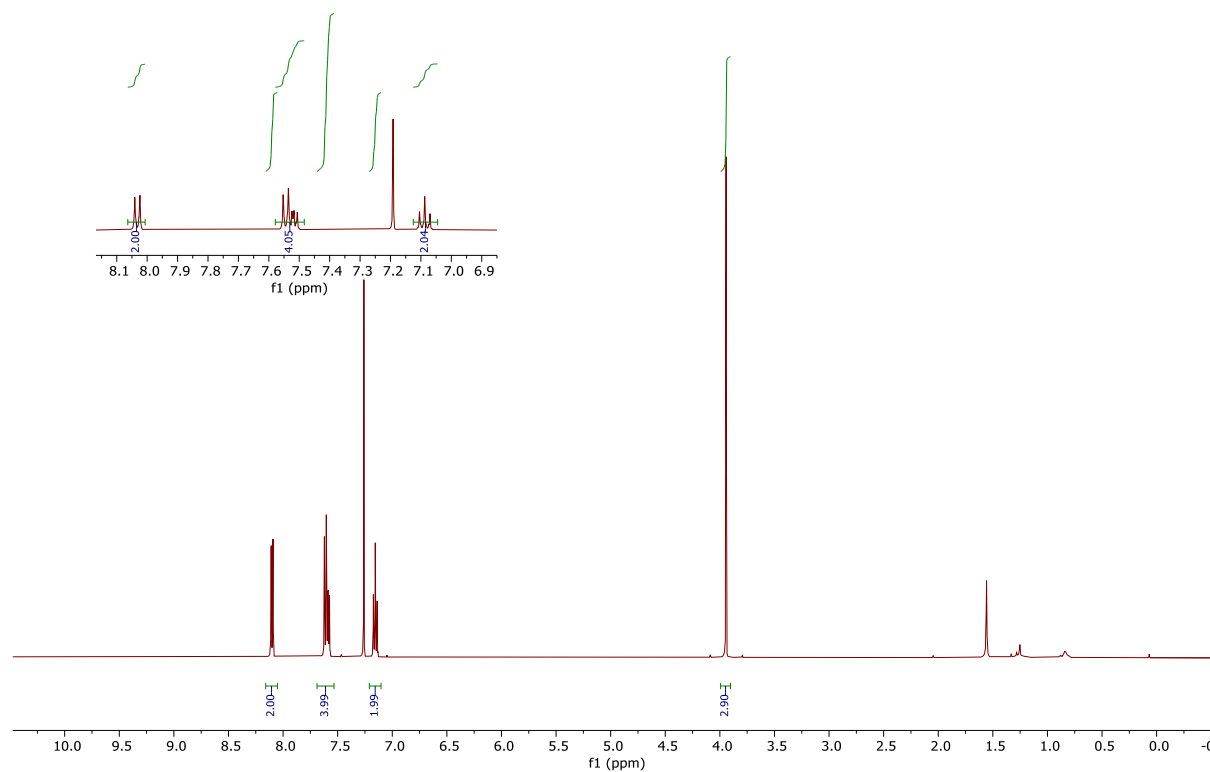
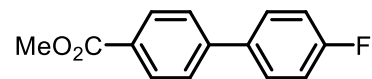

2-(4-Fluorophenyl)-pyridine (3v)

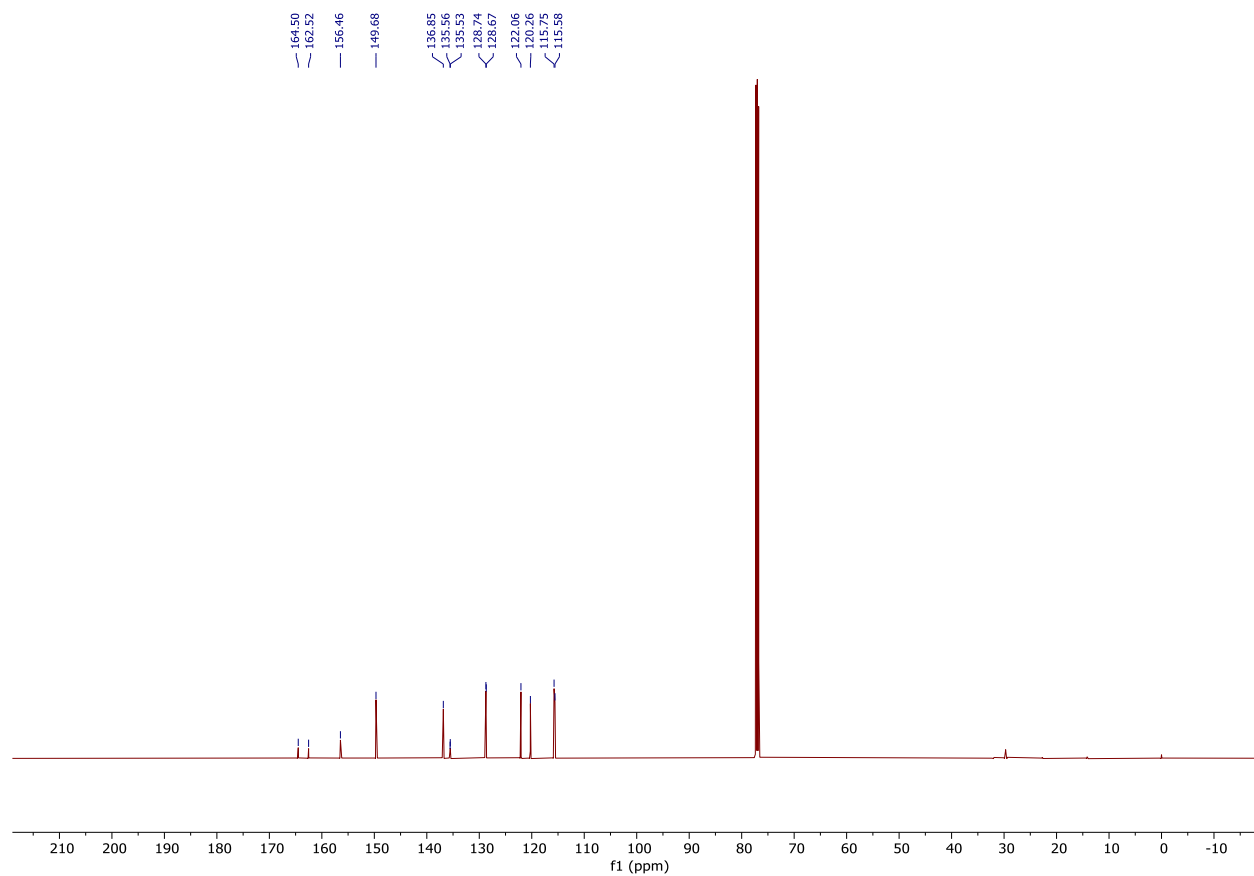
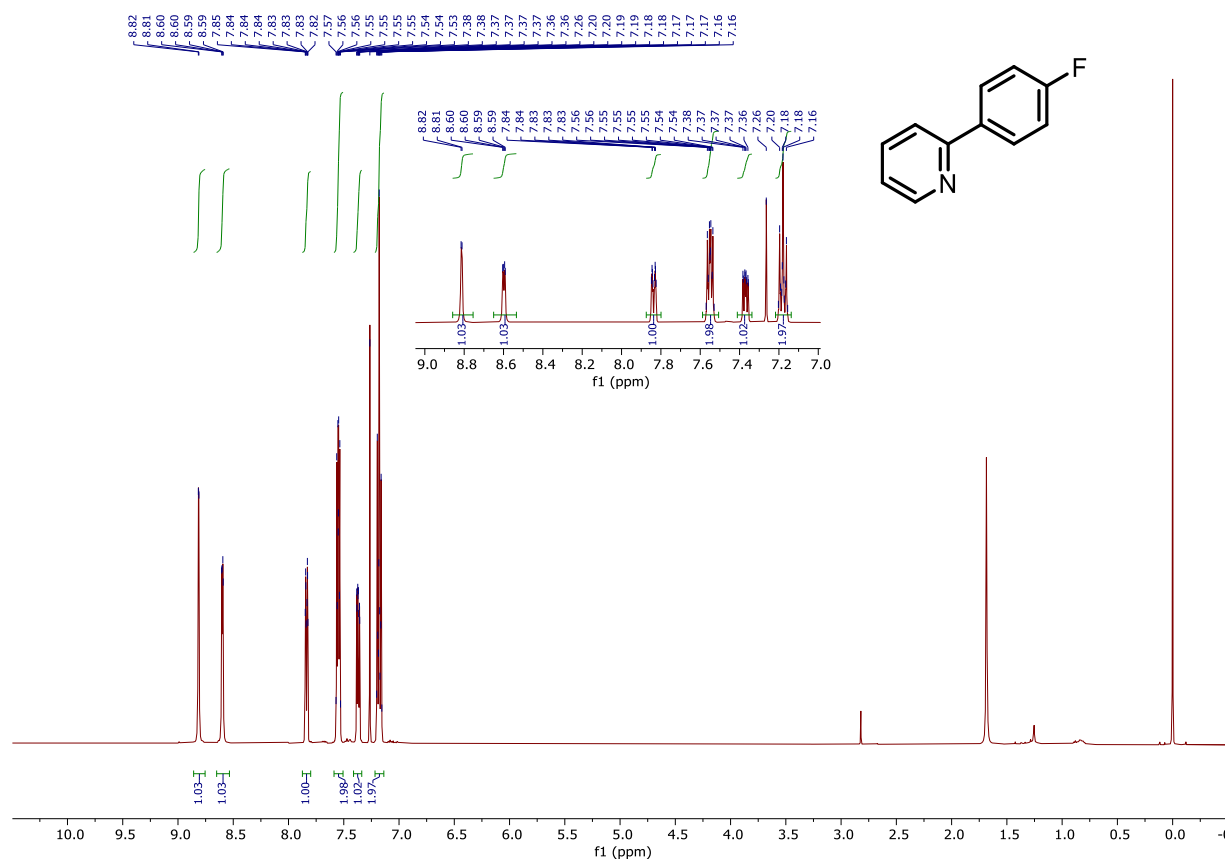

3-(4-Fluorophenyl)-pyridine (3w)

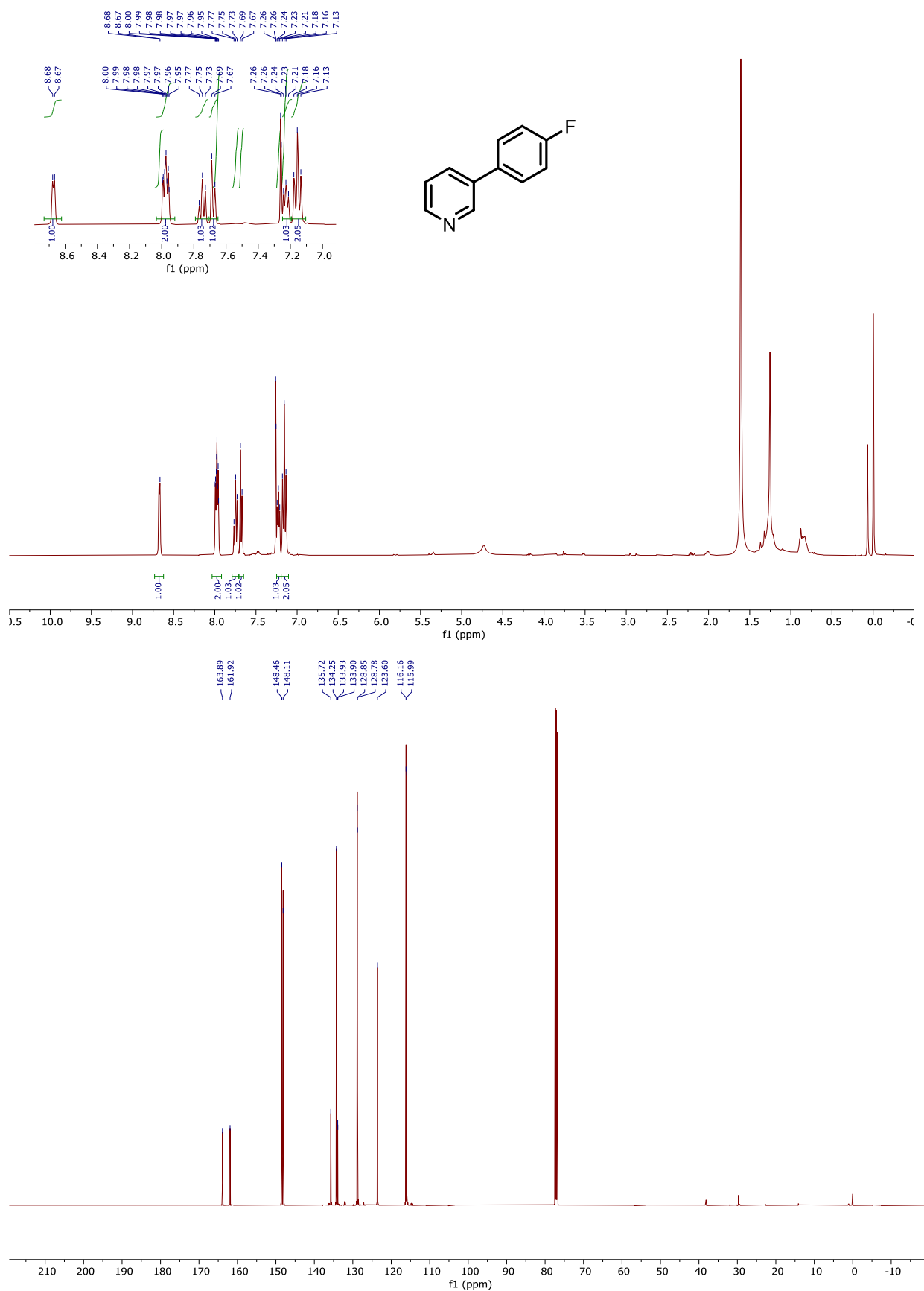

4,4'-Difluoro-1,1'-biphenyl (4a)

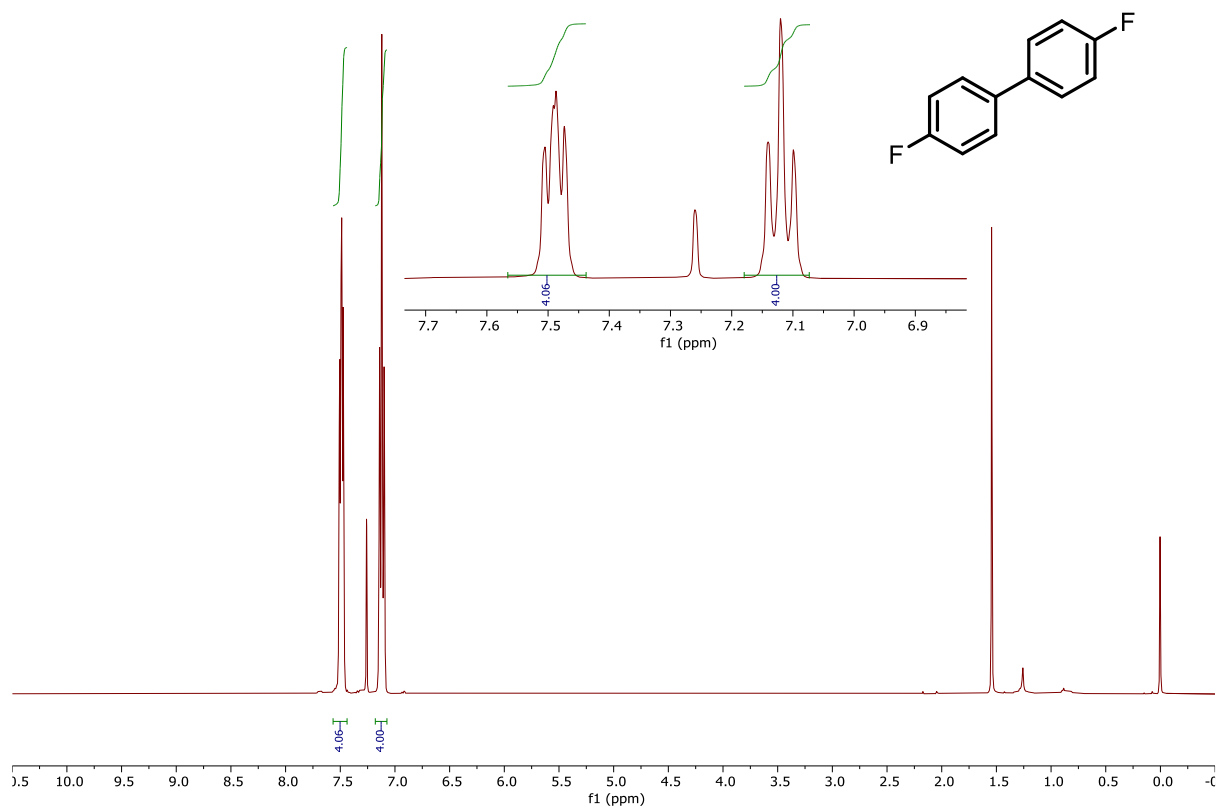

13. References

- [1] K. W. Quasdorf, X. Tian, N. K. Garg, *J. Am. Chem. Soc.* **2008**, *130*, 14422–14423.
- [2] K. W. Quasdorf, M. Riener, K. V. Petrova, N. K. Garg, *J. Am. Chem. Soc.* **2009**, *131*, 17748–17749.
- [3] P. Boehm, S. Roediger, A. Bismuto, B. Morandi, *Angew. Chem. Int. Ed.* **2020**, *59*, 17887–17896.
- [4] S. Zhu, C. Wang, L. Chen, R. Liang, Y. Yu, H. Jiang, *Org. Lett.* **2011**, *13*, 1146–1149.
- [5] J. Wang, J. Zhao, H. Gong, *Chem. Commun.* **2017**, *53*, 10180–10183.
- [6] D. A. Wilson, C. J. Wilson, C. Moldoveanu, A.-M. Resmerita, P. Corcoran, L. M. Hoang, B. M. Rosen, V. Percec, *J. Am. Chem. Soc.* **2010**, *132*, 1800–1801.
- [7] B. Song, T. Knauber, L. J. Gooßen, *Angew. Chem. Int. Ed.* **2013**, *52*, 2954–2958.
- [8] P. Leowanawat, N. Zhang, A.-M. Resmerita, B. M. Rosen, V. Percec, *J. Org. Chem.* **2011**, *76*, 9946–9955.
- [9] K. W. Quasdorf, A. Antoft-Finch, P. Liu, A. L. Silberstein, A. Komaromi, T. Blackburn, S. D. Ramgren, K. N. Houk, V. Snieckus, N. K. Garg, *J. Am. Chem. Soc.* **2011**, *133*, 6352–6363.
- [10] T. Agrawal, S. P. Cook, *Org. Lett.* **2013**, *15*, 96–99.
- [11] S. D. Ramgren, A. L. Silberstein, Y. Yang, N. K. Garg, *Angew. Chem. Int. Ed.* **2011**, *50*, 2171–2173.
- [12] B.-T. Guan, Y. Wang, B.-J. Li, D.-G. Yu, Z.-J. Shi, *J. Am. Chem. Soc.* **2008**, *130*, 14468–14470.
- [13] H.-C. Shen, S. Pal, J.-J. Lian, R.-S. Liu, *J. Am. Chem. Soc.* **2003**, *125*, 15762–15763.
- [14] J.-Y. Zhou, R.-Q. Liu, C.-Y. Wang, Y.-M. Zhu, *J. Org. Chem.* **2020**, *85*, 14149–14157.
- [15] C. Qin, W. Lu, *J. Org. Chem.* **2008**, *73*, 7424–7427.
- [16] M. I. Dawson, P. D. Hobbs, K. A. Derdzinski, W. R. Chao, G. Frenking, G. H. Loew, A. M. Jetten, J. L. Napoli, J. B. Williams, *J. Med. Chem.* **1989**, *32*, 1504–1517.
- [17] G. A. Molander, D. E. Petrillo, N. R. Landzberg, J. C. Rohanna, B. Biolatto, *Synlett*, **2005**, *11*, 1763–1766
- [18] J. L. Bolliger, C. M. Frech, *Adv. Synth. Catal.* **2010**, *352*, 1075–1080.
- [19] J. M. Antelo Miguez, L. A. Adrio, A. Sousa-Pedrares, J. M. Vila, K. K. (Mimi) Hii, *J. Org. Chem.* **2007**, *72*, 7771–7774.
- [20] S. E. Denmark, R. C. Smith, W.-T. T. Chang, J. M. Muhuhi, *J. Am. Chem. Soc.* **2009**, *131*, 3104–3118.
- [21] S. Bernhardt, G. Manolikakes, T. Kunz, P. Knochel, *Angew. Chem. Int. Ed.* **2011**, *50*, 9205–9209.
- [22] L. Wu, B.-L. Li, Y.-Y. Huang, H.-F. Zhou, Y.-M. He, Q.-H. Fan, *Org. Lett.* **2006**, *8*, 3605–3608.
- [23] L. Zhi, H. Zhang, Z. Yang, W. Liu, B. Wang, *Chem. Commun.* **2016**, *52*, 6431–6434.
- [24] N. Louaisil, P. D. Pham, F. Boeda, D. Faye, A.-S. Castanet, S. Legoupy, *Eur. J. Org. Chem.* **2011**, *2011*, 143–149.
- [25] L. Yang, T. Zeng, Q. Shuai, X. Guo, C.-J. Li, *Chem. Commun.* **2011**, *47*, 2161–2163.